



**ZebraNet™**

---

**PrintServer II**

User Guide



© 2009 ZIH Corp. The copyrights in this manual and the software and/or firmware in the label printer described therein are owned by ZIH Corp. Unauthorized reproduction of this manual or the software and/or firmware in the label printer may result in imprisonment of up to one year and fines of up to \$10,000 (17 U.S.C.506). Copyright violators may be subject to civil liability.

This product may contain ZPL<sup>®</sup>, ZPL II<sup>®</sup>, and ZebraLink<sup>™</sup> programs; Element Energy Equalizer<sup>®</sup> Circuit; E<sup>3</sup><sup>®</sup>; and Monotype Imaging fonts. Software © ZIH Corp. All rights reserved worldwide.

ZebraLink and all product names and numbers are trademarks, and Zebra, the Zebra logo, ZPL, ZPL II, Element Energy Equalizer Circuit, and E<sup>3</sup> Circuit are registered trademarks of ZIH Corp. All rights reserved worldwide.

All other brand names, product names, or trademarks belong to their respective holders. For additional trademark information, please see “Trademarks” on the product CD.

**Proprietary Statement** This manual contains proprietary information of Zebra Technologies Corporation and its subsidiaries (“Zebra Technologies”). It is intended solely for the information and use of parties operating and maintaining the equipment described herein. Such proprietary information may not be used, reproduced, or disclosed to any other parties for any other purpose without the express, written permission of Zebra Technologies.

**Product Improvements** Continuous improvement of products is a policy of Zebra Technologies. All specifications and designs are subject to change without notice.

**Liability Disclaimer** Zebra Technologies takes steps to ensure that its published Engineering specifications and manuals are correct; however, errors do occur. Zebra Technologies reserves the right to correct any such errors and disclaims liability resulting therefrom.

**Limitation of Liability** In no event shall Zebra Technologies or anyone else involved in the creation, production, or delivery of the accompanying product (including hardware and software) be liable for any damages whatsoever (including, without limitation, consequential damages including loss of business profits, business interruption, or loss of business information) arising out of the use of, the results of use of, or inability to use such product, even if Zebra Technologies has been advised of the possibility of such damages. Some jurisdictions do not allow the exclusion or limitation of incidental or consequential damages, so the above limitation or exclusion may not apply to you.

---

# Contents



<b>Preface</b> .....	<b>9</b>
Who Should Use This Document .....	10
How This Document Is Organized .....	10
Contacts .....	11
Document Conventions .....	12
Related Documents .....	14
<b>1 • Introduction</b> .....	<b>15</b>
Overview .....	16
Illustration .....	16
Requirements .....	18
Operating Systems .....	18
Browser Support .....	18
Hardware .....	19
Compatibility .....	20
Installation Types .....	21
PSII Specifications .....	22
<b>2 • Installation</b> .....	<b>23</b>
External PSII .....	24
Internal PSII .....	27
<i>X11</i> , <i>X111</i> , <i>R140</i> , <i>105SL</i> , and <i>PAX</i> Series .....	27
Z4Mplus/Z6Mplus .....	31
ZebraNet Utilities .....	37
ZebraNet View Java Applet .....	40

<b>3 • Getting Started</b> .....	<b>43</b>
Before You Begin .....	44
Assigning an IP Address .....	46
With Dynamic Host Configuration Protocol (DHCP) .....	46
Without DHCP .....	46
In a Non-Windows Environment .....	49
Setting Alerts .....	52
ZebraNet View .....	52
ZebraLink .....	54
Checking Printer Configuration Settings .....	58
ZebraNet View .....	58
Browser .....	60
Setting Up a ZebraNet Connect IP .....	63
Windows NT 4.0/Windows 2000 .....	63
Windows 95/98/Me .....	64
IPX (NetWare) .....	65
Enabling Protocols .....	66
WebView .....	66
ZebraNet View .....	69
Defaulting the PSII .....	70
WebView .....	70
ZebraNet View .....	71
Test Button .....	72
<b>4 • Printing Configurations</b> .....	<b>73</b>
BSD (Berkeley Software Distribution)-Style Print Queue .....	74
Configuring the Print Queue .....	74
System V Queue Installation .....	75
Configuring Operating System V Queue for ZebraNet Printing .....	75
Prerequisites .....	75
UNIX Configuration .....	75
<b>5 • NetWare Print Configuration</b> .....	<b>77</b>
Printing in PServer Mode .....	78
<b>6 • Using Printing Protocols</b> .....	<b>81</b>
IPP .....	82
FTP .....	83

- A • PrintServer II ..... 85**
  - PSII Features ..... 86
  - Status and Configuration ..... 86
  - Print Server Status ..... 95
  - Reset ..... 97
  - Restore ..... 98
- B • ZebraLink ..... 99**
  - WebView ..... 100
  - Home Page ..... 100
  - Alert Setup ..... 109
- C • ZebraNet Utilities ..... 115**
  - ZebraNet View ..... 116
  - ZebraNet Alert ..... 119
    - PSII Alerts ..... 119
    - ZebraLink Alerts ..... 119
    - ZebraNet Alert Using SNMP ..... 120
    - Sending Email to Your Zebra Printer ..... 121
    - Open Alert ..... 125
  - ZebraNet Connect ..... 125
  - ZebraNet View Java Applet ..... 126
- D • Hardware Troubleshooting ..... 129**
  - Troubleshooting the PSII ..... 130
    - Resetting to Factory Defaults ..... 130
    - Status Indicator ..... 130
    - ZebraNet View Utility Discovery or Configuration Problems ..... 131
    - Unable to Print ..... 131
    - Unable to Configure Device ..... 131
    - HP JetAdmin or HP Web JetAdmin ..... 131
- E • Frequently Asked Questions ..... 133**
  - FAQs ..... 134

**Glossary** ..... **137**  
**Index** ..... **141**



---

# Preface

The Preface discusses the topics and illustrates standards that are used throughout this guide.

**Contents**

- Who Should Use This Document . . . . . 10
- How This Document Is Organized . . . . . 10
- Contacts . . . . . 11
- Document Conventions . . . . . 12
- Related Documents . . . . . 14

## Who Should Use This Document

This User Guide is intended to be used by any person who will install and work with the ZebraNet PrintServer II.

## How This Document Is Organized

The ZebraNet PrintServer II User and Reference Guide consists of these chapters:

Title	Content Description
<i>Introduction</i>	This chapter provides a high-level overview of the ZebraNet PrintServer II (PSII), installation instructions, standard network configurations, and how to work with PSII.
<i>Installation</i>	This chapter provides information on how to install PSII (external and internal) and the ZebraNet Utilities.
<i>Getting Started</i>	This chapter provides you with information on how to work with the most frequently used PSII features.
<i>Printing Configurations</i>	This chapter provides information and instructions on configuring your printer for remote BSD-style LPD printing on the UNIX operating system.
<i>NetWare Print Configuration</i>	This chapter provides you with instructions on how to configure Novell's NetWare for printing to PSII.
<i>Using Printing Protocols</i>	This chapter provides information and steps to set up your PSII to support Internet Printing Protocol (IPP).
<i>PrintServer II</i>	This appendix provides you with details on the most commonly used PSII features.
<i>ZebraLink</i> <i>(for ZebraLink-enabled printers)</i>	This appendix provides you with detailed information that allows you to use the enhanced functionality of your ZebraLink-enabled printer with the PSII.
<i>ZebraNet Utilities</i>	This appendix provides you with details on ZebraNet Utilities, the software suite of printer administration tools that complements and enhances both ZebraLink and the ZebraNet family of connectivity products.
<i>Hardware Troubleshooting</i>	This section provides you with solutions to known issues.
<i>Frequently Asked Questions</i>	This section is a compiled group of frequently asked questions (FAQs) about PSII.
<i>Glossary</i>	This section is a glossary of terms that are specific to the PSII.



## Contacts

Technical Support via the Internet is available 24 hours per day, 365 days per year.

**Web Site:** [www.zebra.com](http://www.zebra.com)

**E-mail Back Technical Library:**

E-mail address: [emb@zebra.com](mailto:emb@zebra.com)

Subject line: Emailist

**Self Service Knowledge Base:** [www.zebra.com/knowledgebase](http://www.zebra.com/knowledgebase)

**Online Case Registration:** [www.zebra.com/techrequest](http://www.zebra.com/techrequest)

Which Department Do You Need?	The Americas	Europe, Africa, Middle East, India	Asia Pacific
<b>Regional Headquarters</b>	Zebra Technologies International, LLC 333 Corporate Woods Parkway Vernon Hills, IL 60061-3109 U.S.A. T: +1 847 793 2600 Toll-free +1 800 423 0422 F: +1 847 913 8766	Zebra Technologies Europe Limited Dukes Meadow Millboard Road Bourne End Buckinghamshire, SL8 5XF United Kingdom T: +44 (0) 1628 556000 F: +44 (0) 1628 556001	Zebra Technologies Asia Pacific Pte. Ltd. 120 Robinson Road #06-01 Parakou Building Singapore 068913 T: + 65 6858 0722 F: +65 6885 0838
<b>Technical Support</b> For questions on the operation of Zebra equipment and software, please call your distributor. For additional assistance, contact us. <i>Please have your model and serial numbers available.</i>	T: +1 877 ASK ZEBRA (275 9327) F: +1 847 913 2578 Hardware: <a href="mailto:ts1@zebra.com">ts1@zebra.com</a> Software: <a href="mailto:ts3@zebra.com">ts3@zebra.com</a> Kiosk printers: T: +1 866 322 5202 E: <a href="mailto:kiosksupport@zebra.com">kiosksupport@zebra.com</a>	T: +44 (0) 1628 556039 F: +44 (0) 1628 556003 E: <a href="mailto:Tseurope@zebra.com">Tseurope@zebra.com</a>	T: +65 6858 0722 F: +65 6885 0838 E: China: <a href="mailto:tschina@zebra.com">tschina@zebra.com</a> All other areas: <a href="mailto:tsasiapacific@zebra.com">tsasiapacific@zebra.com</a>
<b>Repair Service Department</b> For back-to-base service and repair.	T: +1 877 ASK ZEBRA (275 9327) F: +1 847 821 1797 E: <a href="mailto:repair@zebra.com">repair@zebra.com</a> To request a repair in the U.S., go to <a href="http://www.zebra.com/repair">www.zebra.com/repair</a> .	T: +44 (0) 1772 693069 F: +44 (0) 1772 693046 New requests: <a href="mailto:ukrma@zebra.com">ukrma@zebra.com</a> Status updates: <a href="mailto:repairupdate@zebra.com">repairupdate@zebra.com</a>	T: +65 6858 0722 F: +65 6885 0838 E: China: <a href="mailto:tschina@zebra.com">tschina@zebra.com</a> All other areas: <a href="mailto:tsasiapacific@zebra.com">tsasiapacific@zebra.com</a>
<b>Technical Training Department</b> For Zebra product training courses.	T: +1 847 793 6868 T: +1 847 793 6864 F: +1 847 913 2578 E: <a href="mailto:ttamerica@zebra.com">ttamerica@zebra.com</a>	T: +44 (0) 1628 556000 F: +44 (0) 1628 556001 E: <a href="mailto:Eurtraining@zebra.com">Eurtraining@zebra.com</a>	T: + 65 6858 0722 F: +65 6885 0838 E: China: <a href="mailto:tschina@zebra.com">tschina@zebra.com</a> All other areas: <a href="mailto:tsasiapacific@zebra.com">tsasiapacific@zebra.com</a>
<b>Inquiry Department</b> For product literature and distributor and dealer information.	T: +1 877 ASK ZEBRA (275 9327) E: <a href="mailto:inquiry4@zebra.com">inquiry4@zebra.com</a>	T: +44 (0) 1628 556037 F: +44 (0) 1628 556005 E: <a href="mailto:mseurope@zebra.com">mseurope@zebra.com</a>	E: China: <a href="mailto:GCmarketing@zebra.com">GCmarketing@zebra.com</a> All other areas: <a href="mailto:APACchannelmarketing@zebra.com">APACchannelmarketing@zebra.com</a>
<b>Customer Service Department (US)</b> <b>Internal Sales Department (UK)</b> For printers, parts, media, and ribbon, please call your distributor or contact us.	T: +1 877 ASK ZEBRA (275 9327) E: <a href="mailto:clientcare@zebra.com">clientcare@zebra.com</a>	T: +44 (0) 1628 556032 F: +44 (0) 1628 556001 E: <a href="mailto:cseurope@zebra.com">cseurope@zebra.com</a>	T: +65 6858 0722 F: +65 6885 0836 E: China: <a href="mailto:order-csr@zebra.com">order-csr@zebra.com</a> All other areas: <a href="mailto:csasiapacific@zebra.com">csasiapacific@zebra.com</a>

Key: T: Telephone  
F: Facsimile  
E: E-mail

## Document Conventions

The following conventions are used throughout this document to convey certain information:

**About this Chapter Sections** These sections list and describe each main section of the chapter, including the initial page numbers of those sections. These sections primarily serve as hyperlink components for the Adobe Acrobat .pdf version of this guide.

**Alternate Color** (online only) Cross-references contain hot links to other sections in this guide. If you are viewing this guide online in .pdf format, you can click the cross-reference (royal blue text) to jump directly to its location.

**Command Line Examples** All command line examples appear in Courier font. For example, you would type the following to get to the Post-Install scripts in the bin directory:

```
Ztools
```

**Files and Directories** All file names and directories appear in Courier font. For example, the Zebra<version number>.tar file and the /root directory.

**Caution, Important, Note, Tools, and Example** These topics are defined in the following example:

---

**Caution** • Advises you that failure to take or avoid a specified action could result in loss of data.

---



---

**Caution** • Warns you of a potential electric shock situation.

---



---

**Caution** • Advises you that failure to take or avoid a specified action could result in personal injury.

---



**Important** • Provides information that is essential to the completion of a task.



**Note** • Indicates neutral or positive information that emphasizes or supplements important points of the main text.



**Tools** • Identifies the tools you need to accomplish a task.



**Example** • Provides an example, often a scenario, to better clarify a section of text.

**Illustration Instructions** Used when an illustration contains either information about a dialog box or step(s) to accomplish in a dialog box.

One illustration instruction identifies a section of the dialog box and the other shows steps to follow.

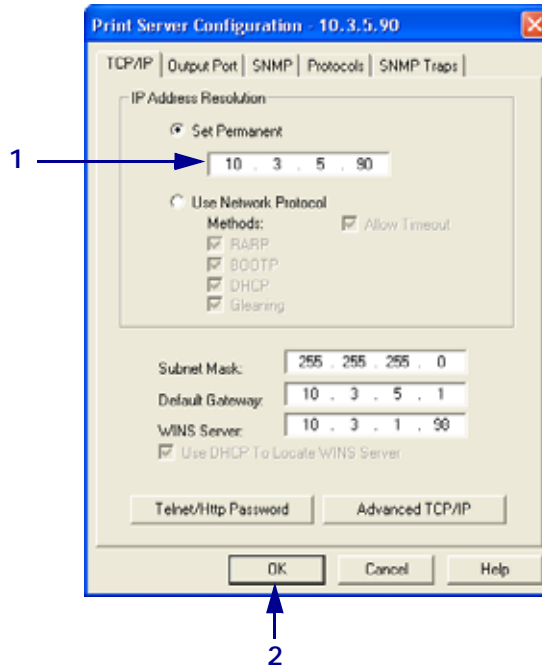

1	Set Permanent text-box.
2	<ol style="list-style-type: none"> <li>a. In the Set Permanent text-box, type in the print server's IP address.</li> <li>b. When you are finished, click OK.</li> </ol>

## Related Documents

In addition to the *ZebraNet PrintServer User Guide*, the following documents might be helpful references while using PSII:



**Note** • Most of these documents are available on our Web site.

- *ZPL II<sup>®</sup> Programming Guide For Firmware Version x.14 and later*
- *ZPL II<sup>®</sup> Programming Guide For x.10 through x.13 Firmware*
- *EPL2 Programmer's Manual*
- *EPL1 Line Mode Manual*



---

# Introduction

This chapter provides a high-level overview of the PrintServer II (PSII), installation types, standard network configurations, and how to work with PSII.

## Contents

Overview .....	16
Illustration .....	16
Requirements .....	18
Operating Systems .....	18
Browser Support .....	18
Hardware .....	19
Compatibility .....	20
Installation Types .....	21
PSII Specifications .....	22

## Overview

The PrintServer II (PSII) is an optional factory- or field-installed interface device that supports network connection of the Zebra printer. PSII also provides a browser-type user interface that supports both the configuration of print server settings and the generation of unsolicited printer status messages to email-equipped devices.

ZebraLink-enabled printers offer an additional set of web pages that allow the user to set printer specific settings, as well as configure additional unsolicited alerts to be sent via email or SNMP.

If your printer also has ZebraNet Utilities, you have even more functionality. For details, see [ZebraNet Utilities on page 17](#).



**Important** • You can download the most recent version of ZebraNet Utilities from our Web site: [www.zebra.com](http://www.zebra.com).

## Illustration

This illustration shows the flow of all the components that work with PSII. The table that follows identifies the components and how they enhance each respective device:

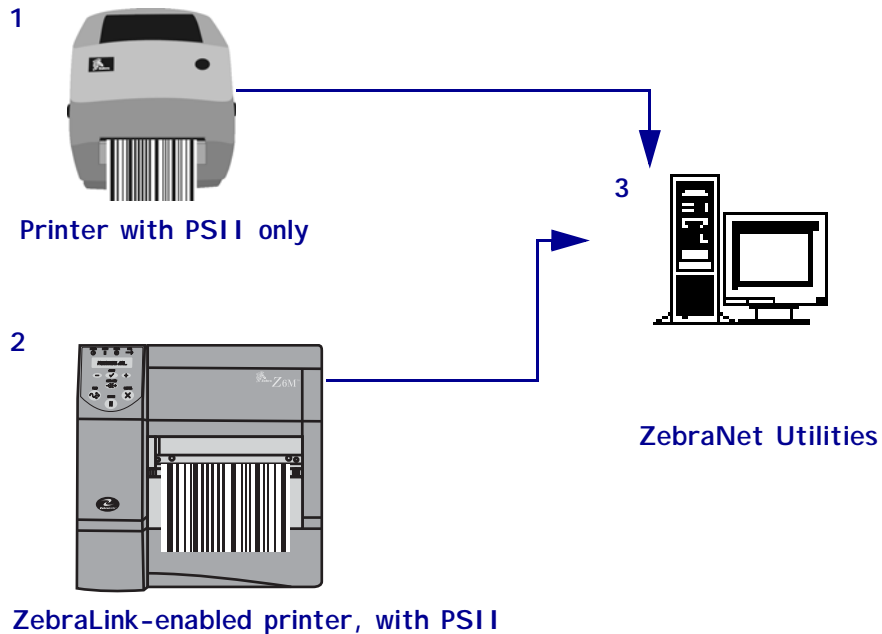

Components		Description
1	<b>Printer with PSII only</b>	PSII gives your printer these features: <ul style="list-style-type: none"><li>• allows the remote monitoring and configuration capability of the PSII using a browser.</li><li>• allows you to send unsolicited printer status messages via email-enabled devices.</li></ul>
2	<b>ZebraLink-enabled printer with PSII</b>	A ZebraLink-enabled printer with PSII gives you all the above-mentioned features (WebView and Alert).  <b>Note</b> • PSII can be either field- or factory-installed for additional features. For details, see <i>Installation Types on page 21</i> .
3	<b>ZebraNet Utilities</b>	ZebraNet <sup>®</sup> Utilities is a suite of software programs that work with PSII and enhance the features of ZebraLink resident within ZPL-based printers. The features include: <ul style="list-style-type: none"><li>• ZebraNet Alert lets you configure multiple event alerts per device with different alerts going to different people. You are notified of alerts from either visual or audio cues. You can also generate advanced alert reports.</li><li>• ZebraNet Connect IP lets you, with Windows, enable simple printer selection of an IP addressable printer.</li><li>• ZebraNet View allows you to locate printers automatically. ZebraNet View searches on parameters such as IP address, subnet, printer model, printer status, and many other user-defined characteristics. It also offers powerful device management capabilities.</li><li>• ZebraNet View Java Applet is a Java-based version of the popular ZebraNet View. It gives you ZebraNet View capabilities in a non-Windows environment.</li></ul>

## Requirements

This section lists the minimum requirements for PSII, which include operating systems, browser support, and hardware.

### Operating Systems

These are the platforms supported by ZebraNet Utilities:

- Windows™ NT®, 95, 98, 2000, Me
- Novell® versions 3 and 4 Netware®
- UNIX®
- Linux

### Browser Support

The ZebraNet View Java Applet is supported by any Java-enabled browser:

- Internet Explorer 4.0+
- Netscape Navigator 4.08+
- Any browser that is HTML 1.1 compliant



## Hardware

These are the minimum hardware requirements:

Printers	External	Internal Field Upgrade	Internal Factory
<i>Xi</i> Series ( <i>XiII</i> and <i>XiIII</i> )	•	•	•
<i>Xi4</i>	•		
<i>R140</i>	•	•	•
<i>PAX</i> Series ( <b>excluding</b> <i>PAX4</i> )	•	•	•
<i>Z</i> Series <sup>®</sup>	•		
<i>Stripe</i> <sup>®</sup> Series	•		
<i>Z4Mplus</i> <sup>™</sup>	•	•	•
<i>Z6Mplus</i> <sup>™</sup>	•	•	•
<i>105SL</i>	•	•	•
<i>105 Se/160S</i>	•		
<i>2746</i>	•		
<i>2746e</i>	•		•
<i>2684</i>	•		
<i>DA402, T402</i>	•		
<i>2844 (EPL)</i>	•		•
<i>2844-Z (ZPL)</i>	•		•
<i>Ht-146</i>	•		•
<i>2824</i>	•		•
<i>ZM400</i> <sup>™</sup>	•		
<i>ZM600</i> <sup>™</sup>	•		

## Compatibility

This section identifies the various components that are compatible with PSII.

**ZebraNet Wireless Card Socket Option (WCSO)** PSII is fully compatible with WCSO.

**Software** HP JetAdmin, HP Web JetAdmin™, and HP OpenView™ all work with PSII.

## Installation Types

PSII can be factory- or field-installed, as follows:

**Factory** Factory-installations are for new Zebra printers that are built with the internal PSII option.

**Field** Field-installations are for Zebra printers already in the field that do not have the PSII device installed. The PSII option can be installed on existing printers, as follows:

- External PSII — attaches to the printer parallel port



**Important** • This installation must be performed by a qualified service technician.

- Internal PSII — for the appropriate Zebra printers, this option connects directly to the main logic board

## PSII Specifications

**Network Connection** 10BASE-T UTP RJ45 connection. Auto senses IEEE- 802.3, Ethernet II, IEEE- 802.2, and IEEE 802.2/SNAP frame formats

**Printer Connection** Bi-directional, IEEE- 1284 Centronics parallel port

**User Interface** Activity indicator: bi-color display of operational status; test button: diagnostic test and configuration printing

**Size (external ZebraNet PrintServer II)** Length: 3.6" / 91.4 mm, Width: 2.5" / 63.5 mm, Height: 0.8" / 20.3 mm

**Weight (external ZebraNet PrintServer II)** .5 oz. / 71 g.

**Power** Maximum 250mA at 5.25VDC; power provided by the printer (Centronics pin 18, 5VDC at 200mA)

**Environment** Operating Temperature: 0° to 104°F (0° to 40°C); Storage Temperature: -4° to 140°F (-20° to 60°C); Operating Humidity: 25 to 85% non-condensing

**Agency Approvals** FCC Class B, Canadian ICES-003 "Class B", EN55022 Class B, EN55024, AS/NZS3548



---

# Installation

This chapter provides information on how to install PSII (external and internal) and the ZebraNet Utilities.

## Contents

External PSII .....	24
Internal PSII .....	27
XIII, XIII, R140, 105SL, and PAX Series .....	27
Z4Mplus/Z6Mplus .....	31
ZebraNet Utilities .....	37
ZebraNet View Java Applet .....	40

## External PSII

This section provides you with an illustration of the external PSII and the steps required for its installation.

This illustration shows an external PSII with the important components identified.

Figure 1 • External PSII

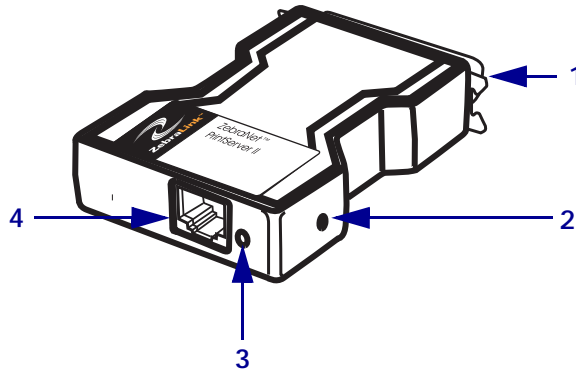

1	Parallel connector
2	Test button
3	Status indicator
4	Ethernet connector



**Note** • When necessary, refer back to this illustration during the installation steps.

### To install an external PS II, complete these steps:

1. Turn off **(O)** the printer.
2. See [Figure 2](#). From the back of the printer, insert the PSII device into the parallel port.  
[Figure 2](#) shows the location and an enlarged view of the parallel port.

Figure 2 • Parallel Port

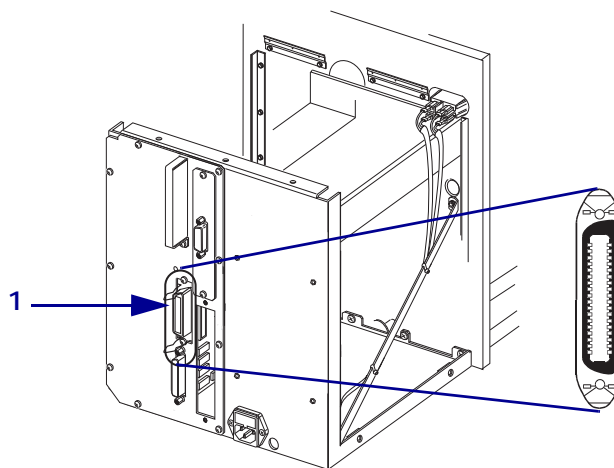

1	Parallel connector
---	--------------------

3. Secure the wire locks.
4. On the back of the PSII, insert a live 10BASE-T cable into the Ethernet connector.
5. Turn on the printer.

A red status indicator blinks during the Power On Self Test (POST) and changes to green when the initialization is finished.

The Test button is a small hole on the PSII device. To press it, you need to insert something small into the hole, like a paperclip.

6. Press the Test button located on the bottom of the PSII. This prints out a PSII configuration label.



**Important** • Label length, DPI and your firmware version:

- For all printers, the minimum label length is 4 in. (10.16 cm).
- For printers with firmware version 7.01 and higher, regardless of the dpi, a 2-inch (5 cm) label prints
- For printers with firmware version 7 and lower, see the table that follows.

This table shows you how to determine the minimum label width needed to print a PSII configuration label for printers with firmware version 7 or lower:

DPI	Inches
600	1.25
300	2.50
200	3.69
150	5.0

This is an example of a PSII configuration label. The numbers identify the settings you need to know. The table following the illustration provides a description of each number.

**Figure 3 • PSII Configuration Label**

```

TCP/IP
  ENABLED
  10.3.4.102
  255.255.255.0
  10.3.4.1
  Enabled
  STATUS
  ADDRESS
  SUBNET MASK
  DEFAULT GATEWAY
  TIMEOUT CHECKING
  1

NETWARE
  ENABLED
  Ethernet 802.3
  Unknown
  STATUS
  FRAME FORMAT
  MODE
  2

GENERAL
  1928107
  0040681D6BAB
  6.30 (A021A)
  SERIAL NUMBER
  HARDWARE ADDRESS
  FIRMWARE VERSION
  3

ERROR
  None
  Error reading from Telnet
  None
  GENERAL
  TCP/IP
  NETWARE

JET ADMIN
  ENABLED
  STATUS

PORT CONFIGURATION
  Online
  ZTC 140XiIII-200dpi
  None
  PORT NAME
  PRINTER STATUS
  CONNECTED TO
  ERROR

ZebraNet™ PRINT SERVER CONFIGURATION
FIRMWARE IN THIS PRINTER IS COPYRIGHTED
  
```

<b>1</b>	This shows the IP address, subnet mask, and default gateway of the PSII device. If the IP address is set at 0.0.0.0, you need the serial number (in number 3) to set the IP address.
<b>2</b>	This shows all the Novell settings.
<b>3</b>	This shows the serial number, hardware address (MAC address), and firmware version of the PSII device.



## Internal PSII

This section provides you with an illustration of the internal PSII and installation steps.

1. Which printer model do you have?

If you have a(n)...	Then...
<i>XiII</i> , <i>XiIII</i> , R140, 105SL, or <i>PAX</i> series printer	See <i>XiII</i> , <i>XiIII</i> , <i>R140</i> , <i>105SL</i> , and <i>PAX Series</i> on page 27.
Z4Mplus or Z6Mplus printer	See <i>Z4Mplus/Z6Mplus</i> on page 31.

### *XiII*, *XiIII*, R140, 105SL, and *PAX* Series

Figure 4 shows you the internal PSII that can be installed into *XiII*, *XiIII*, 105SL, and *PAX* series printers. The important components are identified.

Figure 4 • Internal PSII

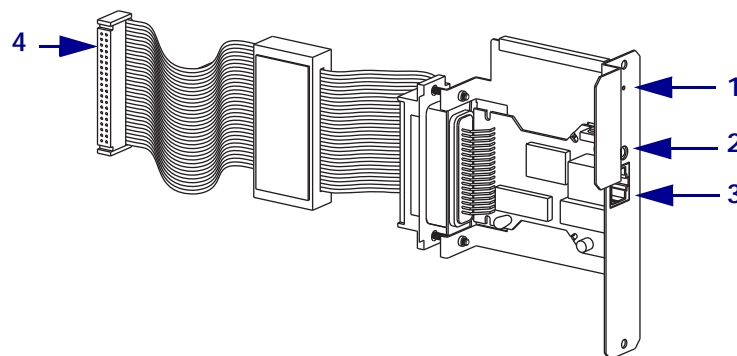

1	Test button
2	Status indicator
3	Ethernet connector
4	Ribbon cable connector



**Caution** • A qualified service technician must perform this installation.

**To install an internal PSII into a *XiII*, *XiIII*, *R140*, *105SL*, and *PAX* Series printer, complete these steps:**



**Tools** • You need these tools to complete this procedure:

- Phillips Screwdriver Set
- 3/32 in. Allen Wrench



1. **Caution** • Observe proper electrostatic safety precautions when handling static-sensitive components such as circuit boards and printheads.

Connect yourself to an antistatic device.



2. **Caution** • Turn off (O) the printer and disconnect it from the power source before performing the following procedure.

Turn off (O) the printer and disconnect the AC power cord and all data cables.

3. From the back of the printer, remove the two screws and the blank cover plate positioned next to the main RS-232 and parallel interface connectors.
4. Which printer model do you have?

If you have a(n)...	Then...
<i>XiII</i> , <i>XiIII</i> series, <i>R140</i> , or a <i>105SL</i>	<ol style="list-style-type: none"> <li>a. See <a href="#">Figure 5</a>.</li> <li>b. To remove the side panel, remove the screws and remove the left side panel.</li> </ol>
<i>PAX</i>	<ol style="list-style-type: none"> <li>a. See <a href="#">Figure 6</a>.</li> <li>b. To remove the side panel, access the electronics by removing the mounting screws from the printer's PCB access panel and sliding the panel out.</li> </ol>

**Figure 5 • Internal PSII  
for the X11, X111 Series, R140, and 105SL**

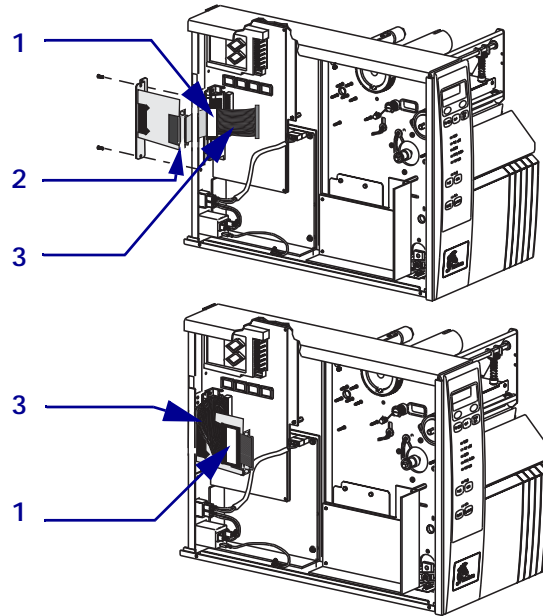

1	Ferrite Bead
2	Data Cable Connector
3	Ribbon Cable

**Figure 6 • Internal PSII  
for the PAX**

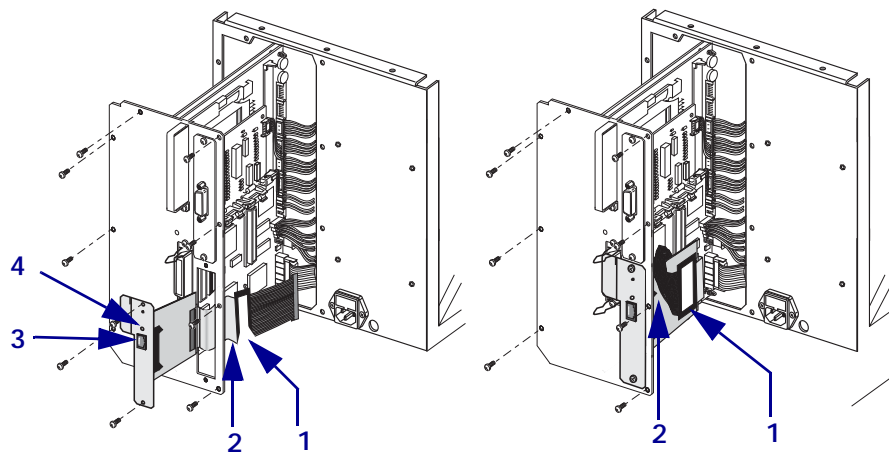

1	Ferrite bead
2	Ribbon cable
3	Status indicator
4	Test button



**Note** • The parallel port on the back of the printer is not operational when the internal PSII is installed. The hardware of the PSII mounting bracket covers the parallel port.

5. Insert the ribbon cable and PSII through the mounting slot.
6. Fold the cable and the ferrite bead back over the mounting bracket, and connect the ribbon cable connector into the keyed Interface Data Cable Connector (J4) on the main logic board.
7. Secure the PSII interface board in place with the cover plate screws that you removed in [step 3](#) of this procedure.
8. Confirm that all small cable connectors are tight.
9. Which printer model do you have?

If you have a(n)...	Then...
XiII, XiIII series, R140, or a 105SL	<ol style="list-style-type: none"> <li>a. See <a href="#">Figure 5</a>.</li> <li>b. Reinstall the left-side panel.</li> <li>c. Replace the screws that you removed in <a href="#">step 3</a> of this procedure.</li> </ol>
PAX	<ol style="list-style-type: none"> <li>a. See <a href="#">Figure 6</a>.</li> <li>b. Reinstall the PCB access panel and gently slide the panel into the back of the print engine.</li> <li>c. Replace the screws that you removed in <a href="#">step 3</a> of this procedure.</li> </ol>

10. This kit includes a label printed with the Ethernet MAC hardware address for the PSII. Remove the backing from the label and affix it to the back of the printer.



11. **Caution** • Reconnect the printer to the power source and turn on (I).

Reconnect the AC power cord and all data cables and turn on (I) the printer.

12. Consult your System Administrator before configuring the PSII for your network! To establish the network connection, refer to the section applicable to your network type.

## Z4Mplus/Z6Mplus

Figure 7 shows you the internal PSII that can be installed into Z4Mplus and Z6Mplus printers. The components you need to be familiar with are identified below.

Figure 7 • Internal PSII for the Z4Mplus/Z6Mplus

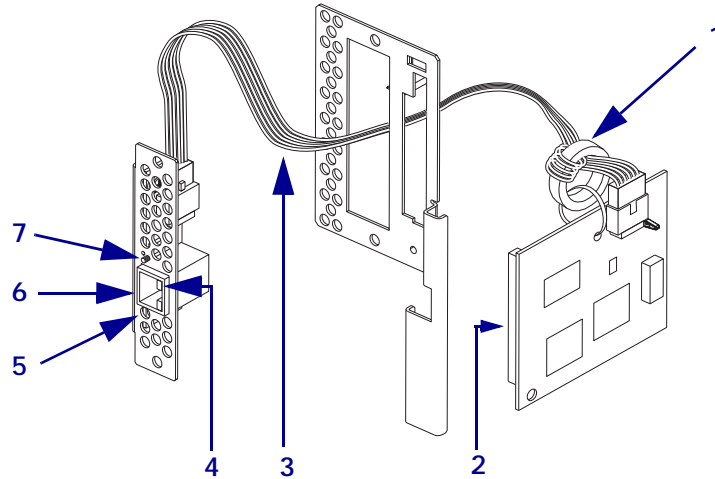

1	Ferrite bead
2	Parallel port socket
3	Ribbon cable
4	Red status indicator
5	Green status indicator
6	Ethernet connector
7	Test button



**Caution** • A qualified service technician must perform this installation.

To install an internal PSII into a Z4Mplus printer, complete these steps:



**Tools** • You need these tools to complete this procedure:

- Flat-blade Screwdriver Set
- 7 mm Nutdriver



1. **Caution** • Observe proper electrostatic safety precautions when handling static-sensitive components such as circuit boards and printheads.

Connect yourself to an antistatic device.



2. **Caution** • Turn off (O) the printer and disconnect it from the power source before performing the following procedure.

Turn off (O) the printer and disconnect the AC power cord and all data cables.

3. See [Figure 8](#). Lift the media door and locate the screw in the middle of the hinge along the top of the printer frame.
4. Remove the screw and the lock washer.

**Figure 8 • Z4Mplus Media Door and Compartment**

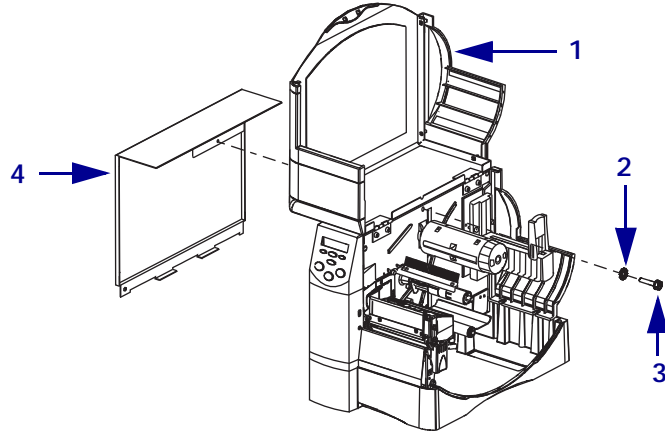

1	Media door
2	Lock washer
3	Screw
4	Electronics cover

5. Close the media door.

6. See [Figure 9](#). To remove the electronics cover, push in and pull up.

**Figure 9 • Z4Mplus Electronics Cover**

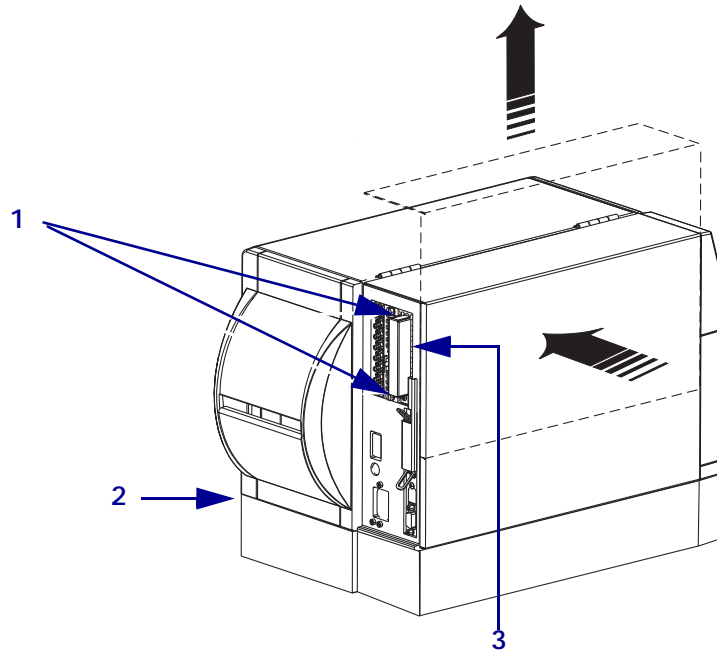

1	Cover plate screws (2)
2	Printer back
3	Cover plate

7. From the back of the printer, use a flat-blade screwdriver to remove the screws and the cover plate.  
This opens the mounting slot on the back of the printer.
8. See [Figure 10](#). To disconnect the PSII, unplug the cable connector from the I/O board.  
You will have the I/O board separate from the PSII board (and the cable connected to it).

Figure 10 • Internal PSII for Z4Mplus

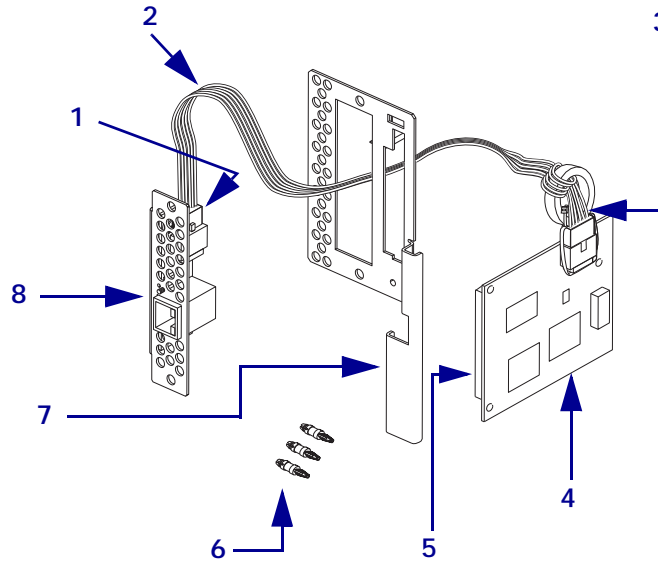

1	Cable connector
2	Cable
3	Cable tie
4	PSII Board
5	Parallel port socket
6	Standoffs (3)
7	Back cover
8	I/O Board



9. See [Figure 11](#). Insert the short ends of each standoff into the holes on the main logic board until you hear a click.

**Figure 11 • Z4Mplus Main Logic Board and Standoffs**

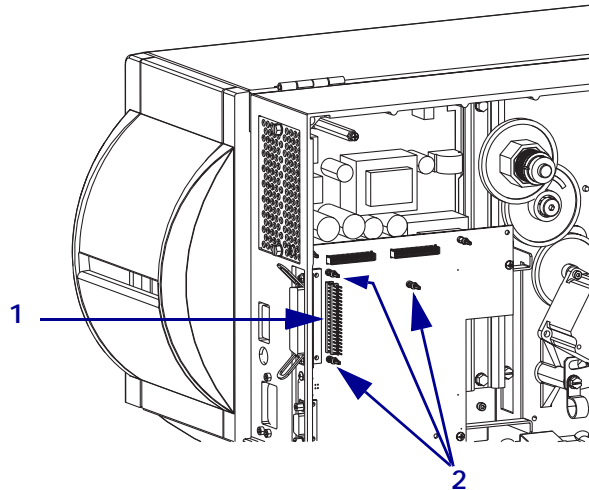

1	Parallel port connector on the main logic board
2	Standoffs (3)

10. See [Figure 10](#) and [Figure 11](#). From the electronics enclosure, plug the parallel port socket of the PSII board into the parallel port connector on the main logic board.
11. Align the holes in the PSII board with the standoffs and snap into place. Be sure the PSII is seated securely.
12. Does your printer have a PCMCIA card installed?

If...	Then...
No	<ol style="list-style-type: none"> <li>a. With the PSII board connected to the main logic board, feed the connector through the mounting slot in the back of the printer.</li> <li>b. Continue with <a href="#">step 13</a>.</li> </ol>
Yes	<ol style="list-style-type: none"> <li>a. With the PSII board connected to the main logic board, feed the connector over the PCMCIA card, then through the mounting slot in the back of the printer.</li> <li>b. Continue with <a href="#">step 13</a>.</li> </ol>

- See [Figure 12](#). Place the I/O board inside the plate, and plug the cable into the connector on the I/O board.

**Figure 12 • Z4Mplus I/O Board and Plate**

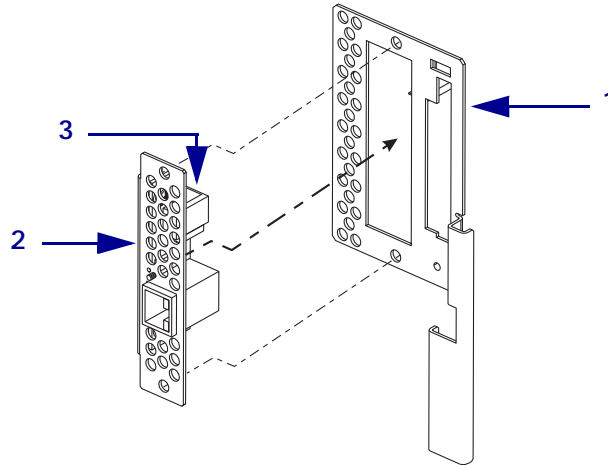

1	Plate
2	I/O Board
3	I/O Board connector



**Note** • The parallel port on the back of the printer cannot be used when the internal PSII is installed. The hardware of the PSII mounting bracket covers the parallel port.

- Using the screws removed in [step 7](#), screw the plate onto the back of the printer.
- Reinstall the electronics cover.



- Caution** • Reconnect the printer to the power source and turn on (I).

Reconnect the AC power cord and all data cables and turn on (I) the printer.

If the green status indicator is solid (not blinking), the PSII has power.

- Consult your System Administrator before configuring the PSII for your network. To establish the network connection, refer to the section applicable to your network type.

## ZebraNet Utilities

The ZebraNet Utilities is a software suite consisting of tools to assist you with the configuration of the PSII device, which gives you the flexibility to make changes to settings, track errors, and more.

If you want to be certain you have the most recent version of the ZebraNet Utilities, you can visit our Web site and download the most recent version.

For more details, see *Overview on page 16* or *ZebraNet Utilities on page 115*.



**Note** • Contact your System Administrator before installing this software. You must have Administrator rights on your network to install most of these utilities.

### To install the ZebraNet Utilities, complete these steps:

The steps that follow reflect the steps and dialogs for a *typical* installation. If you plan to conduct a *custom* installation, the dialogs you see will differ from those in this procedure.

1. Insert the CD-ROM into the drive.



**Important** • Is AutoPlay enabled on your computer?

- **Yes.** Your computer automatically launches the installation.
- **No.** You need to navigate to the Software>ZebraNet Util>setup.exe on the CD-ROM and manually launch the installation.

2. Click Next>.

This dialog box lets you select the utilities that you want to install.

Each of these options has drop-down menus from which to choose.

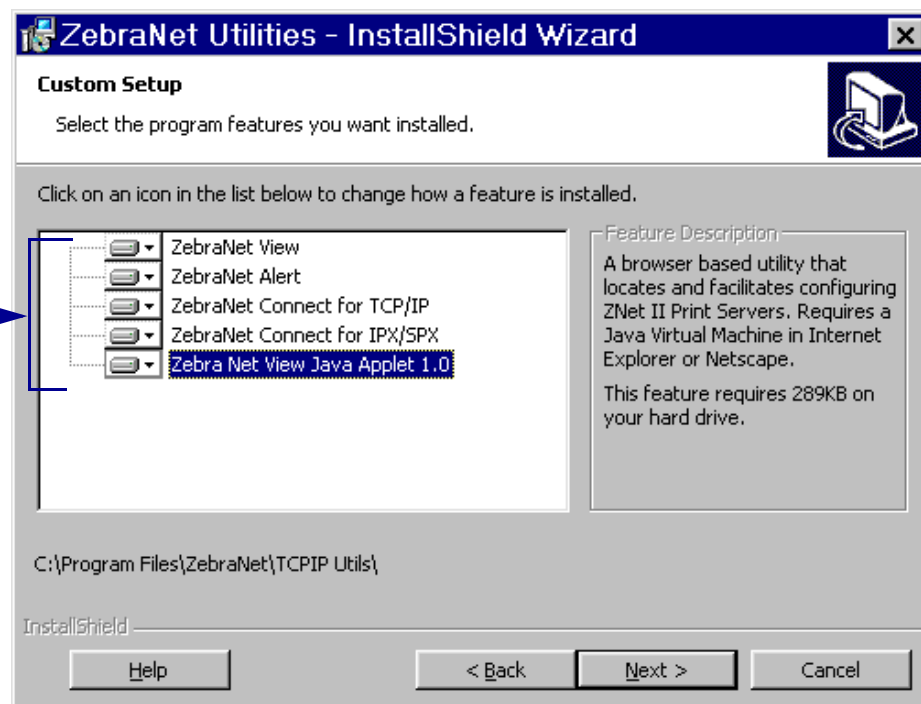



**Important** • If you installed ZebraNet View Java Applet, you must complete the installation steps for *ZebraNet View Java Applet* on page 40.

3. In the *ZebraNet Utilities dialog*, select the features you want to install and click Next>. This dialog box gives you the chance to reset your installation settings.

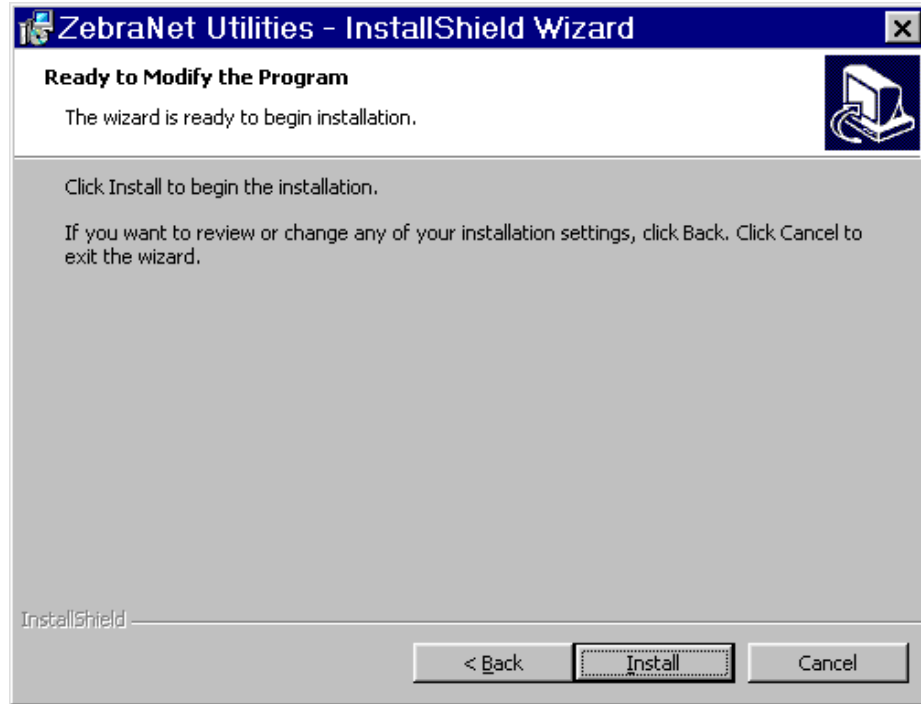

4. In the *ZebraNet Utilities* dialog, you have the option to review and make any changes to your installation settings. When you are satisfied with your installation settings, click **Install**.

When the installation is complete, this dialog opens.

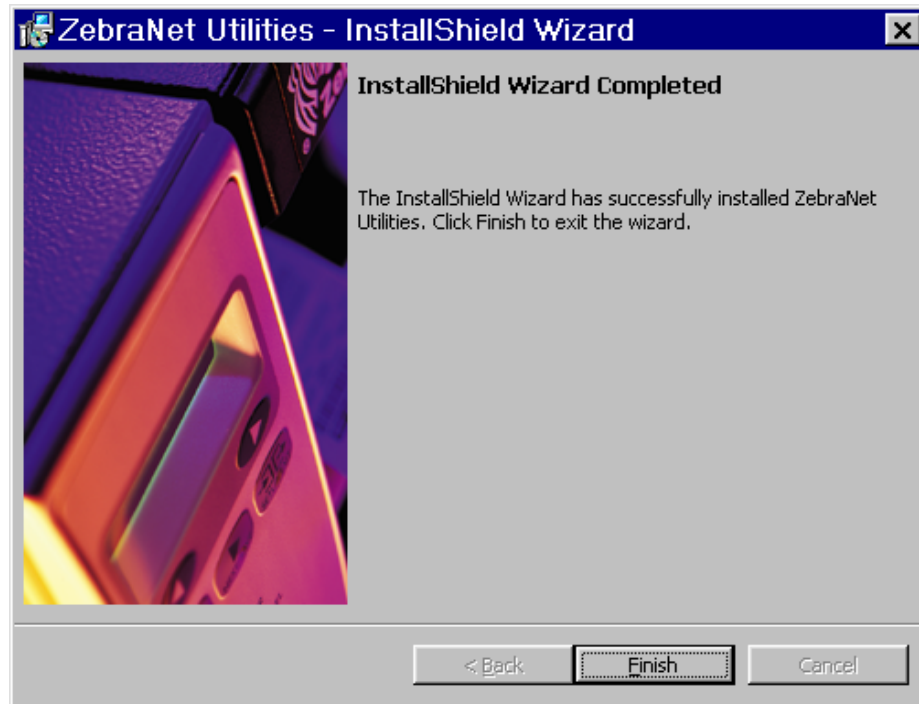

5. Click **Finish**.



**Important** • When the installation is complete, you need to restart your system for the changes to take effect.

## ZebraNet View Java Applet

If you selected ZebraNet View Java Applet when you installed the ZebraNet Utilities, you need to complete a few installation steps to work with this utility.

### To install ZebraNet View Java Applet, complete these steps:

1. From the task bar, select Programs>ZebraNet Utilities>ZebraNet View Java Applet 1.0.  
This *Security Warning* dialog opens.



2. To begin the installation, click Yes.

The *Select Java Plugin Installation* dialog opens.

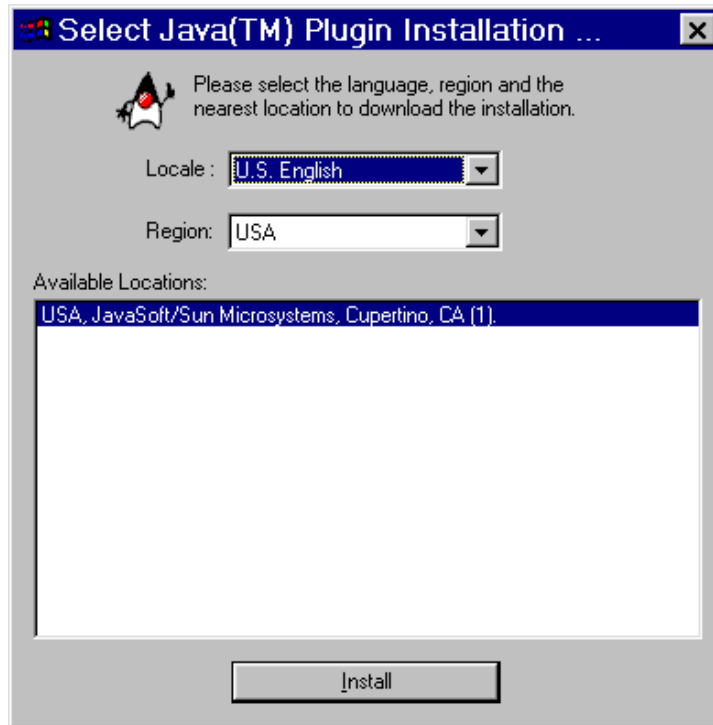

3. Make the selections that apply to your environment, and click Install.

The *Software License Agreement* opens.

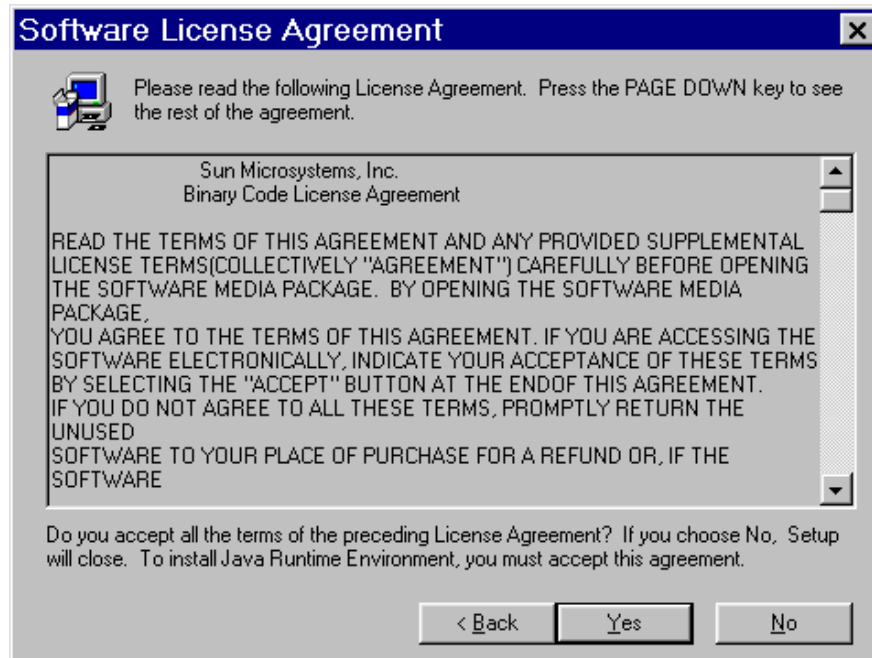

4. Read the License Agreement.
5. To continue with the installation, click Yes.

6. When the installation is complete, click OK.

The Java page opens.

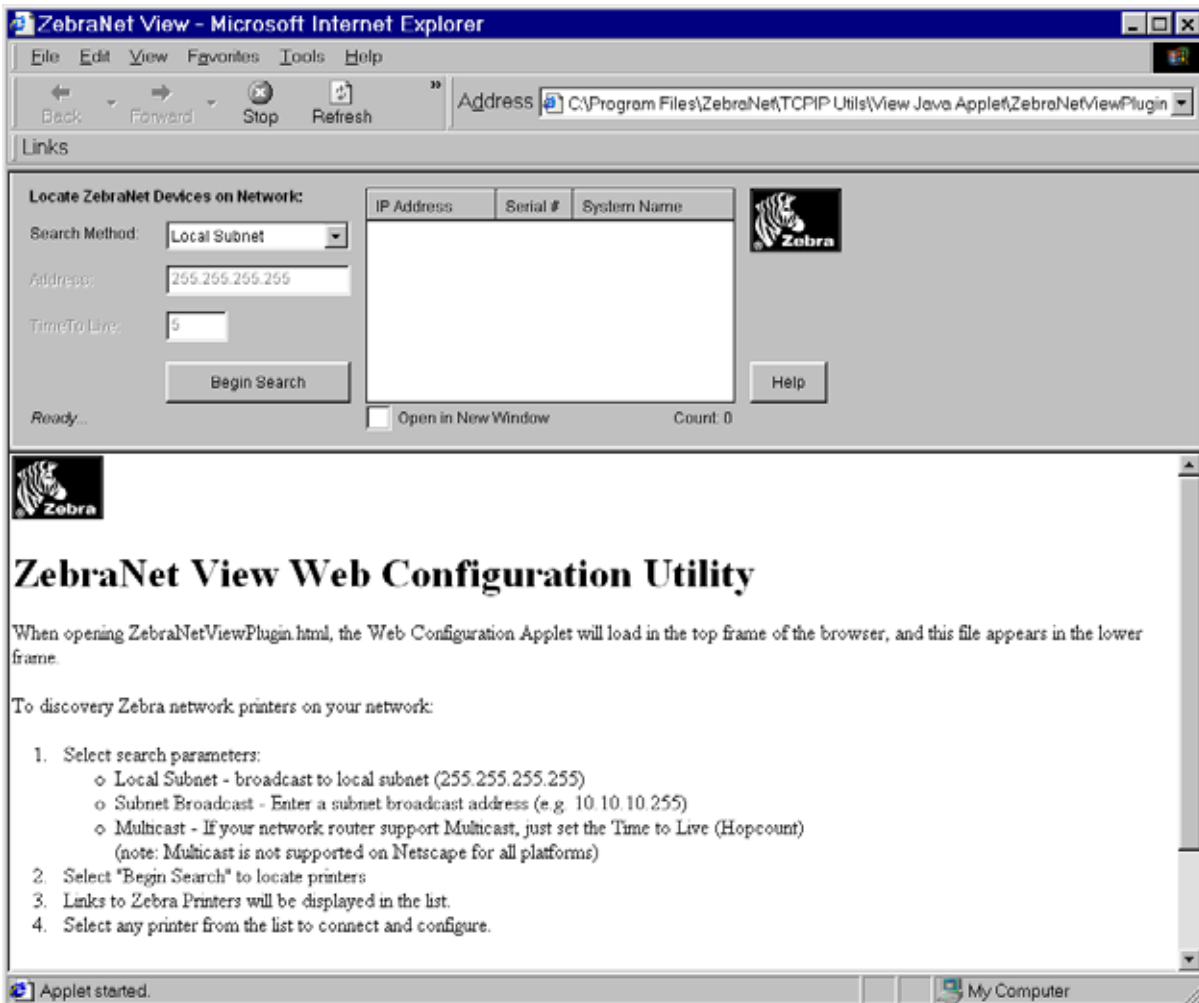

7. You have these options:

- To work with this utility, see *ZebraNet View Java Applet on page 126*.
- To close the utility, click the **X**.





---

# Getting Started

This chapter provides you with information and procedures for working with the most frequently used PSII features.

## Contents

Before You Begin .....	44
Assigning an IP Address .....	46
With Dynamic Host Configuration Protocol (DHCP) .....	46
Without DHCP .....	46
In a Non-Windows Environment .....	49
Setting Alerts .....	52
ZebraNet View .....	52
ZebraLink .....	54
Checking Printer Configuration Settings .....	58
ZebraNet View .....	58
Browser .....	60
Setting Up a ZebraNet Connect IP .....	63
Windows NT 4.0/Windows 2000 .....	63
Windows 95/98/Me .....	64
IPX (NetWare) .....	65
Enabling Protocols .....	66
WebView .....	66
ZebraNet View .....	69
Defaulting the PSII .....	70
WebView .....	70
ZebraNet View .....	71
Test Button .....	72

## Before You Begin

PSII offers many features, but how you access and work with them is dependent on your environment. Before you begin, you need to get information from the PSII configuration label.



**Important** • Make sure the printer is turned off (O).

### To print a PSII configuration label, complete these steps:

1. Turn on (I) the printer and let it complete its power-up cycle.
2. Let the PSII complete its POST cycle.
3. When the above steps are complete, press Test and hold it in for a few seconds before you release it.
  - On the Z4Mplus and Z6Mplus, the Test button for the internal PSII device is a small button on the back of the printer located under the RJ-45 connector. For more details, see [Figure 7 on page 31](#).
  - On any other printer, the Test button on the PSII device is a small hole. For more details, see [Figure 4 on page 27](#).

A PSII configuration label prints. Your configuration label looks similar to [Figure 13 on page 45](#).

Figure 13 • Configuration Label

```
TCP/IP
  ENABLED
  10.3.4.102
  255.255.255.0
  10.3.4.1
  Enabled
  STATUS
  ADDRESS
  SUBNET MASK
  DEFAULT GATEWAY
  TIMEOUT CHECKING

NETWARE
  ENABLED
  Ethernet 802.3
  Unknown
  STATUS
  FRAME FORMAT
  MODE

GENERAL
  1928107
  0040681D6BAB
  6.30 (A021A)
  SERIAL NUMBER
  HARDWARE ADDRESS
  FIRMWARE VERSION

ERROR
  None
  Error reading from Telnet
  None
  GENERAL
  TCP/IP
  NETWARE

JET ADMIN
  ENABLED
  STATUS

PORT CONFIGURATION
  Online
  ZTC 140XiIII-200dpi
  None
  PORT NAME
  PRINTER STATUS
  CONNECTED TO
  ERROR

ZebraNet™ PRINT SERVER CONFIGURATION
FIRMWARE IN THIS PRINTER IS COPYRIGHTED
```

- From the configuration label, you need to get these numbers:  
For details on getting these numbers, see [page 26](#).
  - ADDRESS (IP address)
  - SUBNET MASK
  - DEFAULT GATEWAY
  - SERIAL NUMBER
  - HARDWARE ADDRESS (MAC address)
- On the configuration label that prints out for your PSII device, circle the above-mentioned settings. You can now proceed to *Assigning an IP Address* [on page 46](#).

## Assigning an IP Address

Before you can begin working with PSII, you must get or assign an IP address for the PSII device.



**Important** • Throughout the procedure in this chapter, there are some features that require the default User ID and/or default password. If you are prompted, these are the defaults:

- User ID: admin
- Password: 1234

### With Dynamic Host Configuration Protocol (DHCP)

If your network uses DHCP, your PSII device is assigned a temporary IP address. This is important to know, because you have the option to make the temporary IP address the permanent IP address.



**Note** • Check with your Network Administrator to see whether your network uses DHCP.

### Without DHCP

If your network does not use a dynamic IP addressing system (such as DHCP), you need to set a permanent IP address of the PSII device.

### ZebraNet View

ZebraNet View is the Windows-based print server management and configuration utility that came with your PSII.



**Important** • The remaining sections are dependent on the successful installation of ZebraNet Utilities, which you should have completed on [page 37](#).

**To assign an IP address using ZebraNet View, complete these steps:**

1. From the task bar, select Start>Programs>ZebraNet Utilities>ZebraNet View.



**Important** • On the illustration that follows, take note of the H/W address column and Serial # column. Compare what you see in ZebraNet View with the configuration label you printed out.

The *ZebraNet View* dialog opens:

System Name	IP Address	H/W Address	Serial #	Subnet Mask	Default Go...	Product Type	Product #	Datecode	Status
Focus	10.3.4.102	0040681D6BAB	1928107	255.255.255.0	10.3.4.1	ZebraNet PrintServer	46686	A021A	Warning
Testlab-107	10.3.4.130	0040681D935F	1938271	255.255.255.0	10.3.4.1	ZebraNet PrintServer	46687	A242A	Good
XML/ZPL Hybrid	10.3.4.179	0040681D935A	1938266	255.255.255.0	10.3.4.1	ZebraNet PrintServer	46687	A021A	Good

2. Compare the H/W Address or Serial Number on the PSII configuration label with the H/W Address column on the screen to find the PSII you are working with.
3. When you locate your PSII, select it.
4. From the menu bar, select PrintServer>Configuration.



**Important** • If the PSII does not have an IP address, it shows in the main screen with an IP of 0.0.0.0. If, after 2 minutes, you do not assign an IP Address, the PSII defaults to IP Address 192.168.254.254 or 198.102.102.254 (this depends on your firmware version).

5. If your PSII does not have an IP address, complete these steps:
  - Find your PSII and right-click.
  - In the small dialog that opens, enter an IP Address, click OK.
  - The *ZebraNet View* dialog opens.

**To set the subnet, complete these steps:**

1. From the ZebraNet View menu bar, select PrintServer>Configuration.
2. Click the *TCP/IP* tab.
3. From the *Print Server Configuration>TCP/IP* tab, in the *Subnet Mask* text-box, type in your subnet mask.
4. Confirm it is accurate, and click OK.

The *Print Server Configuration* dialog opens:

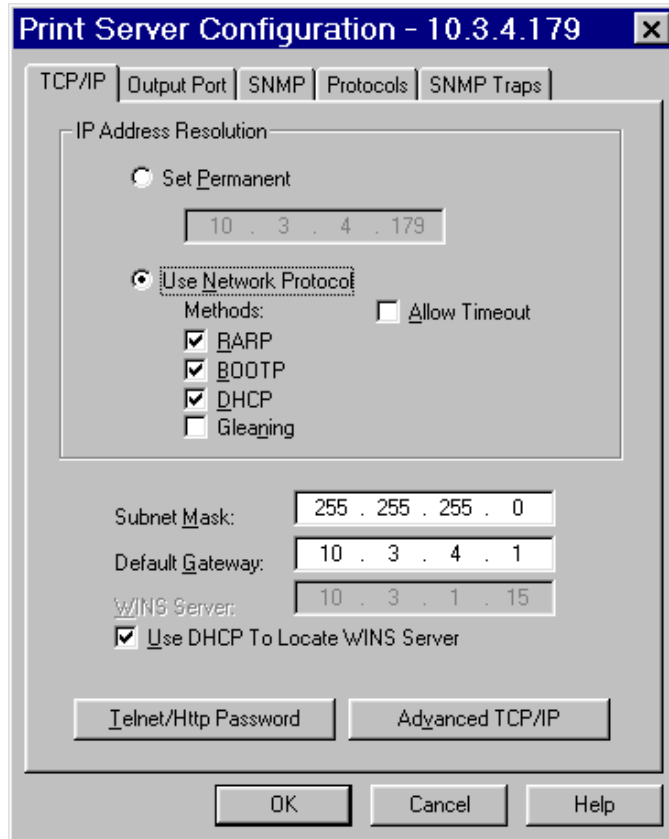

5. To set a permanent IP address, enable the **Set Permanent** radio button.
6. In the **Set Permanent** text-box, type a new IP address and click OK.

**To set the default gateway, complete these steps:**

*These steps are Optional.*

1. From the ZebraNet View menu bar, select PrintServer>Configuration.
2. Click the *TCP/IP* tab.
3. From the *Print Server Configuration>TCP/IP* tab, in the *Default GateWay* text-box, type in your default gateway.
4. Confirm it is accurate, and click OK.

## In a Non-Windows Environment

These steps can be used with all printers. However, the liquid crystal display (LCD) instructions are for printers with an LCD.

### To assign an IP address from the printer LCD, complete these steps:



**Important** • Your PSII must have firmware 6.3 and higher and your Zebra printer must have firmware x.10 or higher with an LCD.

1. Turn on the printer and allow 2 minutes for all systems to complete the self test. If you do not have a network cable in the port, the PSII prints the configuration label when it is ready.
2. On the printer front panel, press SETUP/EXIT.
3. On the printer front panel, press PREVIOUS twice until you reach the network settings menu item.
4. You can edit any of the following network settings in order to communicate with any PSII in your network environment.



**Important** • To change any of these settings, you need to use the default password: 1234.

- `ip resolution` (dynamic, permanent) The printer menu item IP RESOLUTION must be set to PERMANENT if attempting to assign the IP address from the front panel.
- `default gateway` (default setting of 000.000.000.000)
- `subnet mask` (default setting 255.0.0.0)
- `ip address` (if initial default setting is 0.0.0.0, after 2 minutes this defaults to 198.102.102.254 or 192.168.254.254 — depends on firmware version)
- `ip protocol` (gleaning only, rarp bootp, dhcp, dhcp and bootp, all)

## Assigning an IP Address via a Telnet Session

If your environment is not Windows-based, this section is for you. However, this method can be used in a Windows environment, too.

The methods used for assigning an IP address with a Telnet session are **Static Route** and **Gleaning**.



**Important** • This applies to any TCP/IP capable workstation/ host networked with the Zebra printer. Both the workstation/host and the PSII must be on the same network segment.

Before you can Telnet to the PSII and configure it, you must first assign the PSII a temporary IP address.

**Static Route: To use this method, complete these steps:**

1. Turn on the printer and wait for 2 minutes to allow for the device self test.  
During this time, the PSII performs an address broadcast. If no address is assigned to the unit (via DHCP or Bootp), it uses a default address. The default address used varies with the version of firmware the PSII is using. Print the PSII configuration label to confirm the address; for details see [page 44](#).
2. You can use the `route add` command to place the default IP address into the workstation's network routing table.



**Example** • In the next step, \*\*\*\* is the IP address on the PSII configuration label.

3. At the workstation/host command prompt (in Windows, go the DOS prompt), type:  
`route add **** "IP address of the workstation" 0`



**Note** • The zero (0) placed at the end of the "route add" command is optional on some systems.

4. Telnet to the PSII by typing:  
`"Telnet xxx.xxx.xxx.xxx"`  
The password is 1234.
5. When finished, you can alter the appropriate settings. When complete, do a reset and allow the PSII self test to complete before proceeding with any communications activity.

**Gleaning: To use this method, complete these steps:**



**Note** • Gleaning works only on local subnets at routers. It does not pass Address Resolution Protocol (ARP) broadcasts.

A method by which the PSII uses the IP address of the first ping packet that is sent to its Hardware address.

1. Add an entry to the ARP table that assigns an IP address to an Ethernet (Hardware) address.  
The syntax for this command is: `arp -s "temporary ipaddress of print server" "MAC Address (print server hardware address)" arp -s <temporary ip address> <MAC Address>`



**Example** • You would type: `arp -s 10.3.50.59 00-40-68-1D-B9-86`

2. Power cycle the printer.
3. As the printer reboots, begin a continuous ping to the address assigned previously.





**Note** • Most UNIX systems use a continuous ping.

To use a continuous ping from a Windows host, you must issue the command: ping -t "ipaddress".

4. When the PSII begins to respond, stop the ping activity.  
In Windows, Ctrl + C halts the pinging.
5. Telnet to the PSII and assign the appropriate IP address, subnet mask, and gateway if applicable.
6. Once this is complete, reset the PSII.  
For details on resetting the PSII, see *Reset on page 97*.

## Setting Alerts

It is important to understand the relationship between the PSII and the printer when you are establishing alerts. Here are the relationships you need to be aware of:

- Non-ZebraLink-enabled printers — can send alerts on only a specific set of printer errors that are reported in the IEEE 1284 protocol.
- ZebraLink-enabled printers — ZebraLink allows for the printer to send alerts *not* in the IEEE 1284 protocol.

## ZebraNet View

In this section are step-by-steps instructions on how to set up an alert using ZebraNet View. For information on setting up alerts using ZebraLink, see [ZebraLink on page 54](#).

### To set alerts (traps) using ZebraNet View, complete these steps:

1. In the ZebraNet View dialog, from the menu bar select Print Server>Configuration.
2. Click the *SNMP Traps* tab.

The Printer Traps check boxes are the alerts you can set from ZebraNet View.

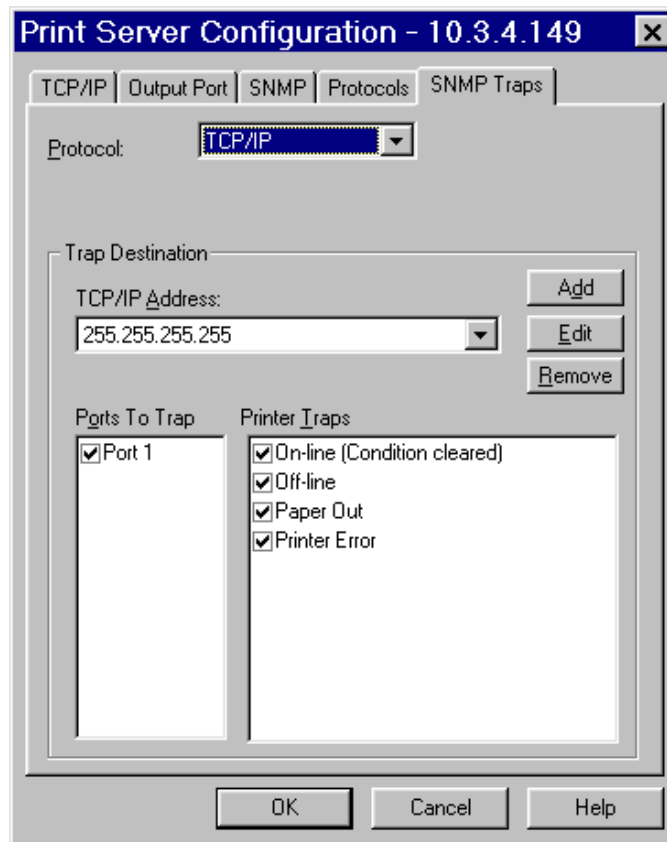

3. Enable the alerts (printer traps) you want to set here and click OK.

4. To monitor the alerts you established, from the task bar select Start>ZebraNet Utilities>ZebraNet Alert.

The *ZebraNet Alert* dialog opens:

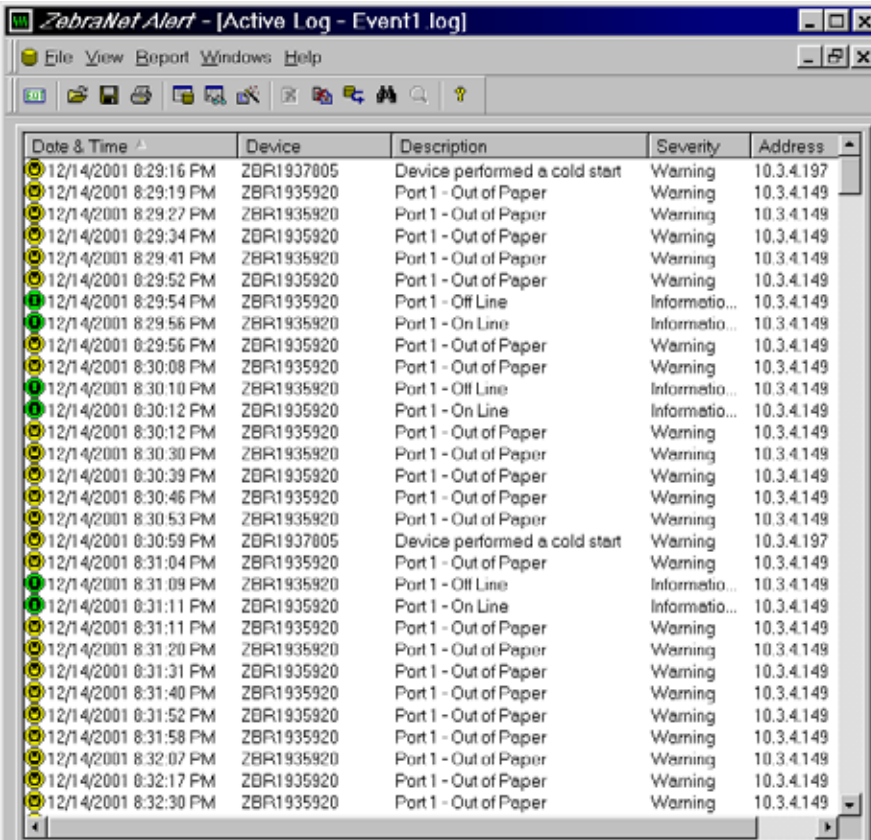

The screenshot shows the 'ZebraNet Alert - [Active Log - Event1 log]' window. It features a menu bar with 'File', 'View', 'Report', 'Windows', and 'Help'. Below the menu bar is a toolbar with various icons. The main area contains a table with the following columns: 'Date & Time', 'Device', 'Description', 'Severity', and 'Address'. The table lists 28 events, including 'Device performed a cold start' and multiple 'Part 1 - Out of Paper' warnings.

Date & Time	Device	Description	Severity	Address
12/14/2001 8:29:16 PM	ZBR1937805	Device performed a cold start	Warning	10.3.4.197
12/14/2001 8:29:19 PM	ZBR1935920	Part 1 - Out of Paper	Warning	10.3.4.149
12/14/2001 8:29:27 PM	ZBR1935920	Part 1 - Out of Paper	Warning	10.3.4.149
12/14/2001 8:29:34 PM	ZBR1935920	Part 1 - Out of Paper	Warning	10.3.4.149
12/14/2001 8:29:41 PM	ZBR1935920	Part 1 - Out of Paper	Warning	10.3.4.149
12/14/2001 8:29:52 PM	ZBR1935920	Part 1 - Out of Paper	Warning	10.3.4.149
12/14/2001 8:29:54 PM	ZBR1935920	Part 1 - Off Line	Information...	10.3.4.149
12/14/2001 8:29:56 PM	ZBR1935920	Part 1 - On Line	Information...	10.3.4.149
12/14/2001 8:29:56 PM	ZBR1935920	Part 1 - Out of Paper	Warning	10.3.4.149
12/14/2001 8:30:08 PM	ZBR1935920	Part 1 - Out of Paper	Warning	10.3.4.149
12/14/2001 8:30:10 PM	ZBR1935920	Part 1 - Off Line	Information...	10.3.4.149
12/14/2001 8:30:12 PM	ZBR1935920	Part 1 - On Line	Information...	10.3.4.149
12/14/2001 8:30:12 PM	ZBR1935920	Part 1 - Out of Paper	Warning	10.3.4.149
12/14/2001 8:30:30 PM	ZBR1935920	Part 1 - Out of Paper	Warning	10.3.4.149
12/14/2001 8:30:39 PM	ZBR1935920	Part 1 - Out of Paper	Warning	10.3.4.149
12/14/2001 8:30:46 PM	ZBR1935920	Part 1 - Out of Paper	Warning	10.3.4.149
12/14/2001 8:30:53 PM	ZBR1935920	Part 1 - Out of Paper	Warning	10.3.4.149
12/14/2001 8:30:59 PM	ZBR1937805	Device performed a cold start	Warning	10.3.4.197
12/14/2001 8:31:04 PM	ZBR1935920	Part 1 - Out of Paper	Warning	10.3.4.149
12/14/2001 8:31:09 PM	ZBR1935920	Part 1 - Off Line	Information...	10.3.4.149
12/14/2001 8:31:11 PM	ZBR1935920	Part 1 - On Line	Information...	10.3.4.149
12/14/2001 8:31:11 PM	ZBR1935920	Part 1 - Out of Paper	Warning	10.3.4.149
12/14/2001 8:31:20 PM	ZBR1935920	Part 1 - Out of Paper	Warning	10.3.4.149
12/14/2001 8:31:31 PM	ZBR1935920	Part 1 - Out of Paper	Warning	10.3.4.149
12/14/2001 8:31:40 PM	ZBR1935920	Part 1 - Out of Paper	Warning	10.3.4.149
12/14/2001 8:31:52 PM	ZBR1935920	Part 1 - Out of Paper	Warning	10.3.4.149
12/14/2001 8:31:58 PM	ZBR1935920	Part 1 - Out of Paper	Warning	10.3.4.149
12/14/2001 8:32:07 PM	ZBR1935920	Part 1 - Out of Paper	Warning	10.3.4.149
12/14/2001 8:32:17 PM	ZBR1935920	Part 1 - Out of Paper	Warning	10.3.4.149
12/14/2001 8:32:30 PM	ZBR1935920	Part 1 - Out of Paper	Warning	10.3.4.149

In this dialog you can view the log of errors and monitor the activity of your printer(s).

## ZebraLink

In this section are step-by-step instructions on how to set up an alert using ZebraLink. For information on setting up alerts using ZebraNet View, see *ZebraNet View* on page 58.



**Important** • If you do not have a ZebraLink-enabled printer, these steps will not work.

### To view Alert Setup using ZebraLink, complete these steps:

1. Open a Web browser.
2. In the *Address* text-box, type your printer's IP address, and press Enter.
3. From the *Printer Home Page*, click **Alert Setup**.

The *Alert Messaging System* dialog opens:

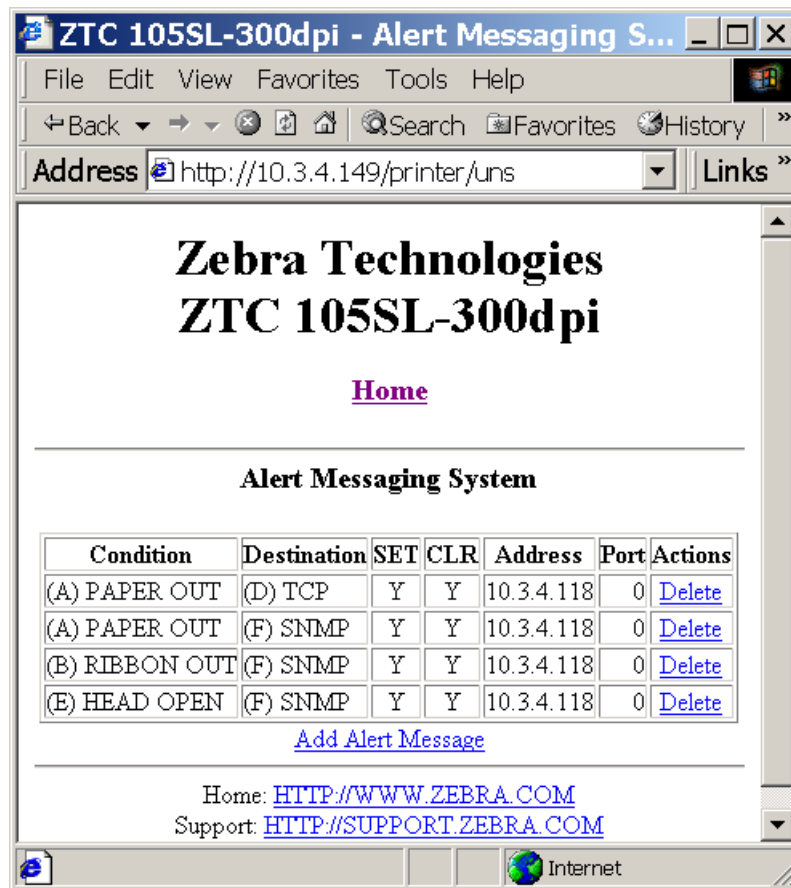

To add an alert, you need the default user ID and password.

4. To add an alert, click **Add Alert Message**.

5. Select accordingly.
6. You can use ZebraNet Alert to monitor alerts set through a ZebraLink-enabled printer.

From this Web page you can add alert messages to notify you when a printer is out of paper, needs a ribbon, and so on.

## Establishing Email Alert Messaging

ZebraNet Alert supports email notification of printer errors sent directly to any valid email address. You can have multiple email addresses set up for routing different error messages, or split notifications between email and other network management tools.

### To begin receiving email notification of errors, complete these steps:

1. From the browser view, in the *Address* text-box type in the printer's IP address.  
The *Printer Home Page* opens.



2. From the *Printer Home Page*, click **Alert Setup**.  
The Alert Setup page shows a list of message notifications and their respective destinations (if no notifications are listed).

3. To set up email notification, go to the *Alert Setup* page and click **Add Alert Message**.  
The *Add Alert Message* page opens:

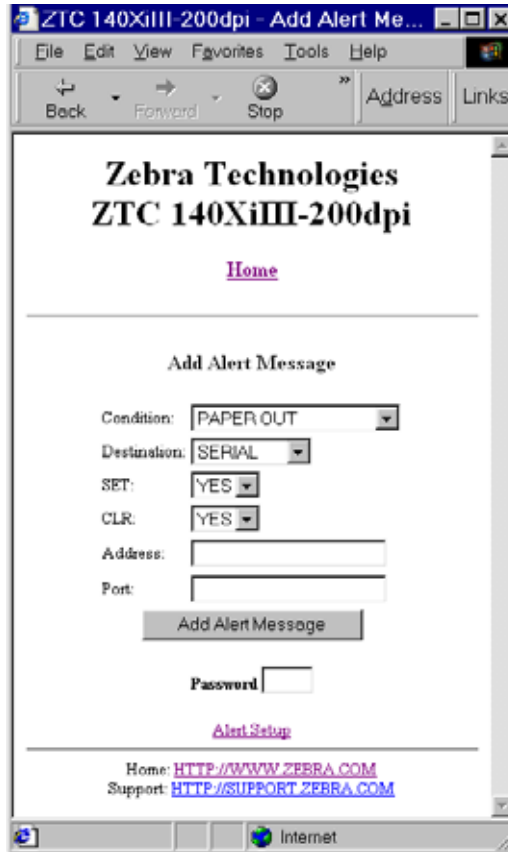

**Important** • The printer accepts only the last configuration made.

4. Specify the condition to send over email, such as **HEAD ELEMENT BAD** or **PAPER OUT**.
5. Set destination to Email.
6. Enter a valid email address for the messages to be sent to.



**Example** • admin@yourcompany.net (The Port field can be ignored for email setup.)

7. Click Add Alert Message.



**Important** • A password is required. If you forget to enter the password, the alerts you just set are deleted.

8. To receive email alert you must give PSII the IP address of your mail server that is running SMTP.
9. To save current settings, click **Save Printer Setting**.

10. Enter the password and click Save Current Configuration.
11. You can continue to add more settings or, if finished:
  - From the Printer Home Page, select PrintServer Settings>Network Communications Setup.
  - Click **SMTP Email Alerts**.



**Note** • The SMTP Server address might be referred to as Mail Server address.

- Specify your SMTP server address.

When these steps are done, you can begin receiving email notification messages.

### To monitor alerts, complete these steps:

1. From the task bar, select Start>Programs>ZebraNet Utilities>ZebraNet Alert.

The *Active Log* dialog opens, displaying a list of all the logged alerts:

Date & Time	Device	Description	Severity	Address
12/14/2001 8:29:16 PM	ZBR1937805	Device performed a cold start	Warning	10.3.4.197
12/14/2001 8:29:19 PM	ZBR1935920	Port 1 - Out of Paper	Warning	10.3.4.149
12/14/2001 8:29:27 PM	ZBR1935920	Port 1 - Out of Paper	Warning	10.3.4.149
12/14/2001 8:29:34 PM	ZBR1935920	Port 1 - Out of Paper	Warning	10.3.4.149
12/14/2001 8:29:41 PM	ZBR1935920	Port 1 - Out of Paper	Warning	10.3.4.149
12/14/2001 8:29:52 PM	ZBR1935920	Port 1 - Out of Paper	Warning	10.3.4.149
12/14/2001 8:29:54 PM	ZBR1935920	Port 1 - Off Line	Information...	10.3.4.149
12/14/2001 8:29:56 PM	ZBR1935920	Port 1 - On Line	Information...	10.3.4.149
12/14/2001 8:29:56 PM	ZBR1935920	Port 1 - Out of Paper	Warning	10.3.4.149
12/14/2001 8:30:08 PM	ZBR1935920	Port 1 - Out of Paper	Warning	10.3.4.149
12/14/2001 8:30:10 PM	ZBR1935920	Port 1 - Off Line	Information...	10.3.4.149
12/14/2001 8:30:12 PM	ZBR1935920	Port 1 - On Line	Information...	10.3.4.149
12/14/2001 8:30:12 PM	ZBR1935920	Port 1 - Out of Paper	Warning	10.3.4.149
12/14/2001 8:30:30 PM	ZBR1935920	Port 1 - Out of Paper	Warning	10.3.4.149
12/14/2001 8:30:39 PM	ZBR1935920	Port 1 - Out of Paper	Warning	10.3.4.149
12/14/2001 8:30:46 PM	ZBR1935920	Port 1 - Out of Paper	Warning	10.3.4.149
12/14/2001 8:30:53 PM	ZBR1935920	Port 1 - Out of Paper	Warning	10.3.4.149
12/14/2001 8:30:59 PM	ZBR1937805	Device performed a cold start	Warning	10.3.4.197
12/14/2001 8:31:04 PM	ZBR1935920	Port 1 - Out of Paper	Warning	10.3.4.149
12/14/2001 8:31:09 PM	ZBR1935920	Port 1 - Off Line	Information...	10.3.4.149
12/14/2001 8:31:11 PM	ZBR1935920	Port 1 - On Line	Information...	10.3.4.149
12/14/2001 8:31:11 PM	ZBR1935920	Port 1 - Out of Paper	Warning	10.3.4.149
12/14/2001 8:31:20 PM	ZBR1935920	Port 1 - Out of Paper	Warning	10.3.4.149
12/14/2001 8:31:31 PM	ZBR1935920	Port 1 - Out of Paper	Warning	10.3.4.149
12/14/2001 8:31:40 PM	ZBR1935920	Port 1 - Out of Paper	Warning	10.3.4.149
12/14/2001 8:31:52 PM	ZBR1935920	Port 1 - Out of Paper	Warning	10.3.4.149
12/14/2001 8:31:58 PM	ZBR1935920	Port 1 - Out of Paper	Warning	10.3.4.149
12/14/2001 8:32:07 PM	ZBR1935920	Port 1 - Out of Paper	Warning	10.3.4.149
12/14/2001 8:32:17 PM	ZBR1935920	Port 1 - Out of Paper	Warning	10.3.4.149
12/14/2001 8:32:30 PM	ZBR1935920	Port 1 - Out of Paper	Warning	10.3.4.149

Active Log - ...

For Help, press F1      Log Events: 1147      Cache Events: 1147      View Eve

2. From this dialog, you can track the printer(s) activity and status.
3. From the menu bar, you can explore all the other features, such as Reports.

## Checking Printer Configuration Settings

This section provides steps on how to check PSII's configuration settings using ZebraNet View and a browser.

### ZebraNet View

To check configuration settings, complete these steps:

1. From the task bar, select Start>Programs>ZebraNet Utilities>ZebraNet View.

The *ZebraNet View* dialog opens:

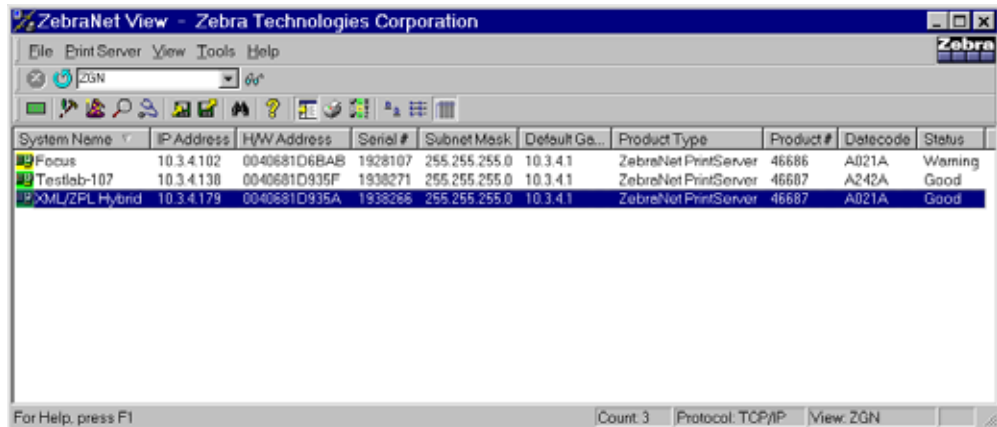



- From the menu bar, select Print Server>Configuration.

The *Print Server Configuration* dialog opens:

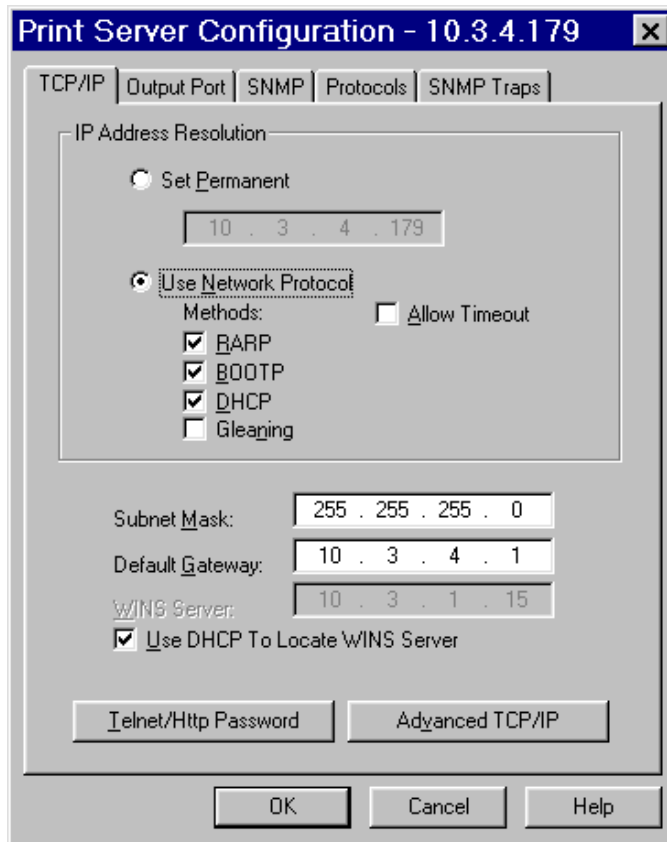

This dialog offers multiple tabs to choose from. Each tab contains various configuration settings that you can change.

For details on the configurations, see [page 116](#).

## Browser

This section provides steps on how to check PSII's configuration settings using its Web pages.

### To access the PSII settings, complete these steps:

1. Open a Web browser.
2. In the *Address* text-box, type your printer's IP address, then press Enter.

Your browser page looks similar to this:



**Note** • Your printer firmware determines how this page looks. This page is from a printer with firmware x.10 and above.



3. From the *Printer Home Page*, click **Print Server Settings**.

The default User ID and password are required.



**Important** • The illustration of the Print Server Settings page is based on a ZPL printer. If you have an EPL printer, the menu options on the Print Server page are slightly different.

The *Print Server Configuration Page* opens:



**Note** • Your printer firmware determines how this page looks. This page is from a printer with firmware x.10 and below.

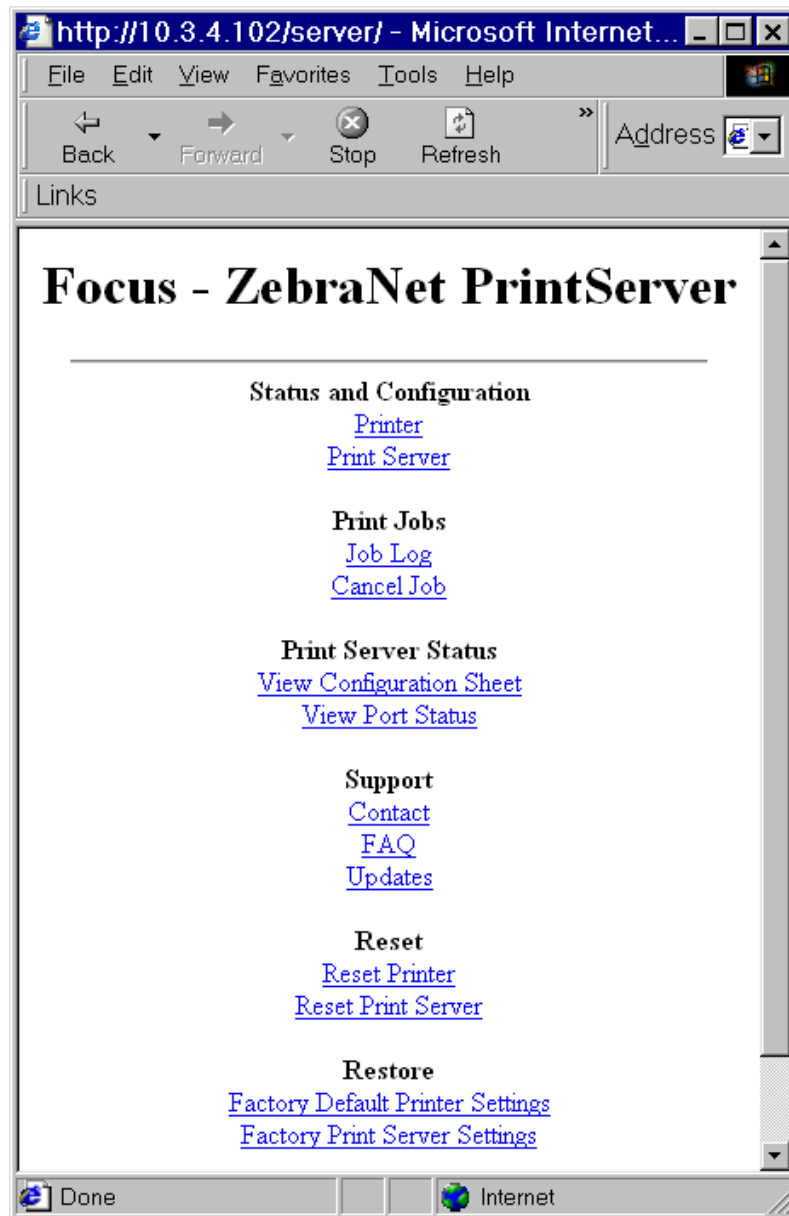

**To access the PSII settings, complete these steps:**

1. From the *Print Server* page, click **Print Server**.

The *Print Server Configuration* page opens:

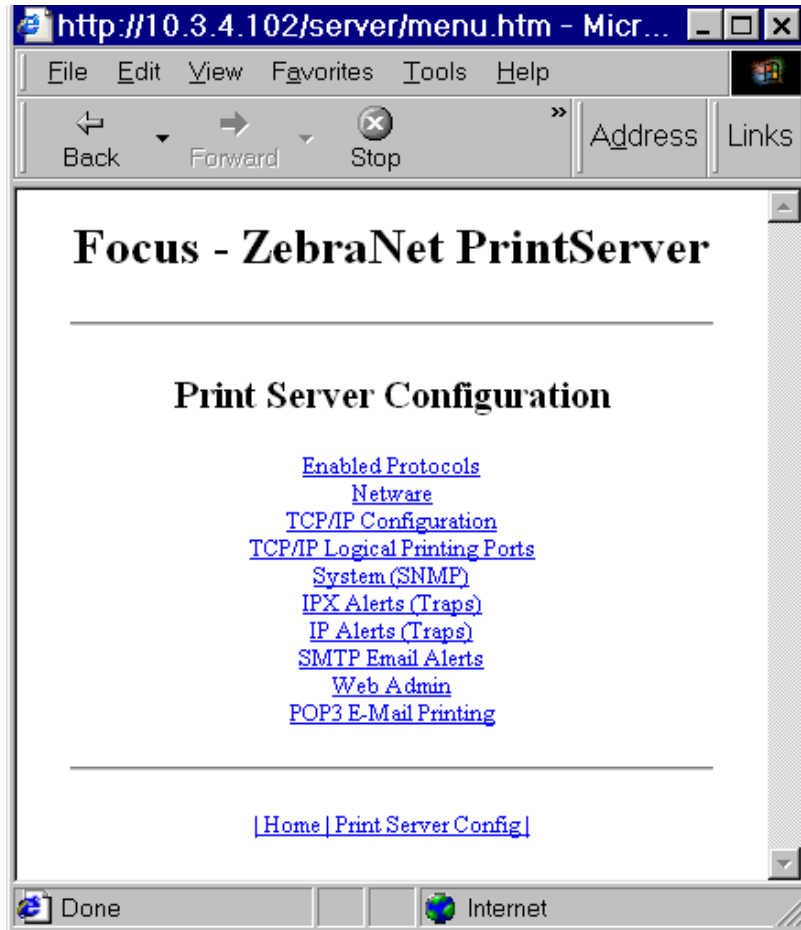

2. For details on the configuration choices, see *Checking Printer Configuration Settings on page 58*.

## Setting Up a ZebraNet Connect IP

ZebraNet Connect IP allows you to send jobs to PrintServers that use Dynamic IP addresses (DHCP). It also notifies you of printer errors, such as *paper out* or *head open*. When print jobs are printed through ZebraNet Connect IP, they are sent directly to PSII and are not routed through a network server, resulting in a reduction of network traffic.



**Note** • The DHCP feature of ZebraNet Connect IP can rediscover a PSII on the local subnet, even when its IP address might be changing (e.g., when using DHCP for IP address resolution). The PSII is relocated by its port name as configured through ZebraNet View (the default name is Serial Number-Port Number). This feature is enabled on the local subnet only. A non-local PSII device is not rediscovered if the IP address changes.

If you have printing problems while using the ZebraNet Connect IP printing port, you may check the status of the port or change its settings through the printer Properties dialog.

- For Windows 95/98, select Port Settings under the Details tab.
- For Windows NT 4.0 or Windows 2000, select Configure Port under the Ports tab.

### Windows NT 4.0/Windows 2000

If you are using the Windows NT 4.0 or Windows 2000 operating system, use the following procedure to set up a printer port for the PSII.

1. From the task bar, select Start>Settings>Printers.
2. Select the Windows printer to use when printing with the PSII.
3. From the menu bar, select File>Properties.
4. To add a ZebraNet Connect IP port, in the Ports tab select Add Port.
5. From the list of Available Printer Ports, select *ZebraNet Connect Monitor* as the type of port to add, and click New Port.



**Note** • If ZebraNet Connect IP monitor is not listed, verify that the ZebraNet Connect IP software has been properly installed. To do this, you need to reinstall the software and choose Modify.

You enter into the Add ZebraNet Connect Port screen, where there is a list of all PSII devices available on the local subnet.

- The TCP/IP monitor searches only the local subnet.
- The IPX/SPX monitor retrieves all devices found in the NetWare bindery.

6. If the port you want to add is listed in the Ports Available on Local Subnet window, select the port name. If the port you want to use is not listed, you can:
  - Select **Cancel** and repeat step 5 to rediscover the print servers.
  - In ZebraNet Connect for IPX/SPX, click **Search** and enter the PrintServer's Network Number and Hardware Address.
  - In ZebraNet Connect, click the **Locate Non-local Device** button and enter the static TCP/IP Address used for the PSII.



**Note** • The ZebraNet Connect for TCP/IP DHCP discovery feature relocates a PSII device on the local subnet by its port name, even if the IP address changes. This feature is enabled on the local subnet only. A non-local PSII device is not rediscovered if the IP address changes.

7. Click **Add**.
8. To close the *Printer Ports* dialog, click **Cancel**.
9. To save the configuration, click **OK**.

Now you can use ZebraNet Connect. Whenever you print to the Windows printer configured with ZebraNet Connect, your print job will go directly to the ZebraNet PSII port.

## Windows 95/98/Me

**To set up a PSII port using Windows 95/Windows 98/Me, complete these steps:**

1. From the task bar, select **Start>Settings>Printers**.
2. Select the Windows printer that you want to print with ZebraNet Connect IP.



**Note** • Under Windows 95, you have to set up the printer for a local port first, then open **Properties** from the **File** menu and continue with the configurations.

3. From the file menu, select **File>Properties**.
4. To add a ZebraNet Connect IP port, in the *Details* tab select **Add Port**.
5. From the *Add Port* dialog, select **Other**, then select the ZebraNet Connect Monitor as the type of port to add.
6. Click **OK**.



**Note** • If ZebraNet Connect IP is not listed, verify that the software has been properly installed.

The Add ZebraNet Connect Port screen opens. There is a list of all PSII devices discovered on the network.

- The TCP/IP monitor searches only the local subnet.
- The IPX/SPX monitor retrieves all devices found in the NetWare bindery.

7. If the port you want to add is listed in the Ports Available on Local Subnet window, select the port name. If the port you want to use is not listed, you can:
  - Select Cancel and repeat step 5 to rediscover the PSII devices.
  - In ZebraNet Connect IP for IPX/SPX, click Search and enter the PSII's network number and hardware address.
  - In ZebraNet Connect IP, click the Locate Non-local Device button and enter the static TCP/IP address used for the PSII.
8. Click Add.
9. To save the configuration, click OK.

Now you can use ZebraNet Connect IP. Whenever you print to the Windows printer configured with ZebraNet Connect IP, your print job will go directly to the PSII port.

## IPX (NetWare)

ZebraNet Connect for IPX/SPX is a utility that allows simple, direct, IPX/SPX printing from your computer to a printer attached to a ZebraNet PSII. Print jobs printed through the ZebraNet Connect utility are sent directly to the PSII and do not require a NetWare server, resulting in a reduction of network traffic.

If you have printing problems while using the PSII Connect printing port, you can check the status of the port or change its settings under the printer Properties window.

- For Windows 95/98, select Port Settings under the Details tab.
  - For Windows NT 4.0 or Windows 2000, select Configure Port under the Ports tab.
- Notify on Printer Error** — This feature checks the printer status prior to printing the job. If a printer error is detected (e.g., printer off-line), the error description is given.
- Notify When Printed** — This feature provides an alert when your job is active on the printer. This is useful if the printer is unusually busy.
- Description** — An optional field in which you can list any useful information about the printer port, such as location.

## Enabling Protocols

You can enable protocols with WebView or ZebraNet View. This section provides you with directions for accessing and enabling protocols using both WebView and ZebraNet View.

### WebView

This section contains directions for accessing protocols using WebView. The browser illustrations were captured from a ZebraLink-enabled printer.

#### To enable protocols using WebView, complete these steps:

1. Open a Web browser.
2. In the *Address* text-box, type your printer's IP address, then press Enter.

Your browser page looks similar to this:

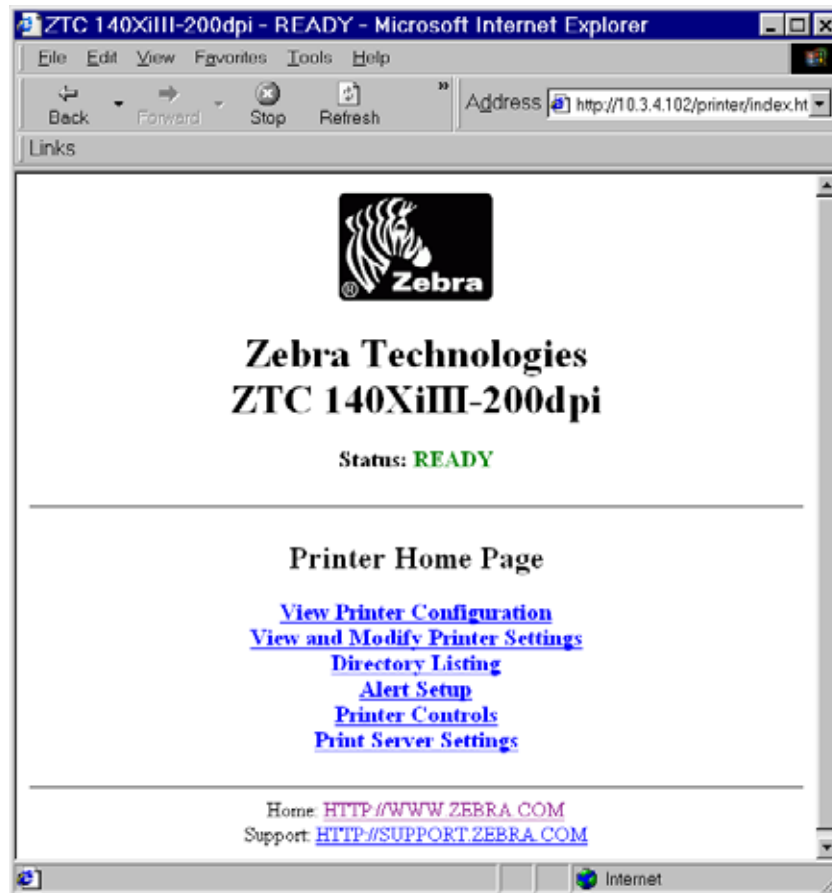

3. From the *Printer Home Page*, click **Print Server Settings**.  
The default User ID and password are required.



4. From the *Print Server* page, click **Print Server**.

The *Print Server Configuration* page opens:

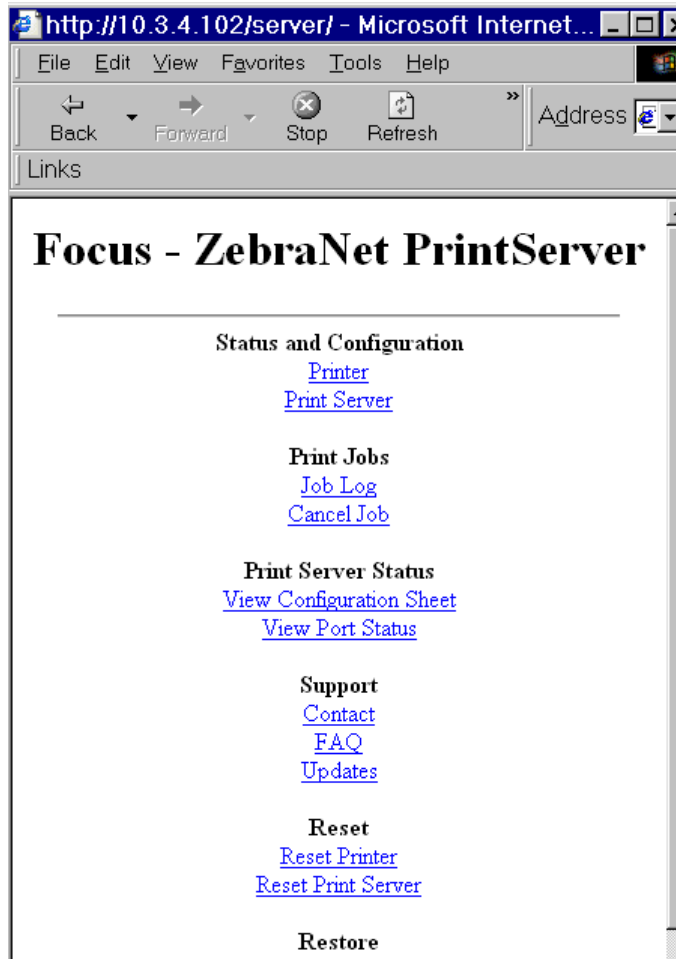

- From the *Print Server Configuration* page, click **Enabled Protocols**.  
The *Protocol Configuration* page opens:

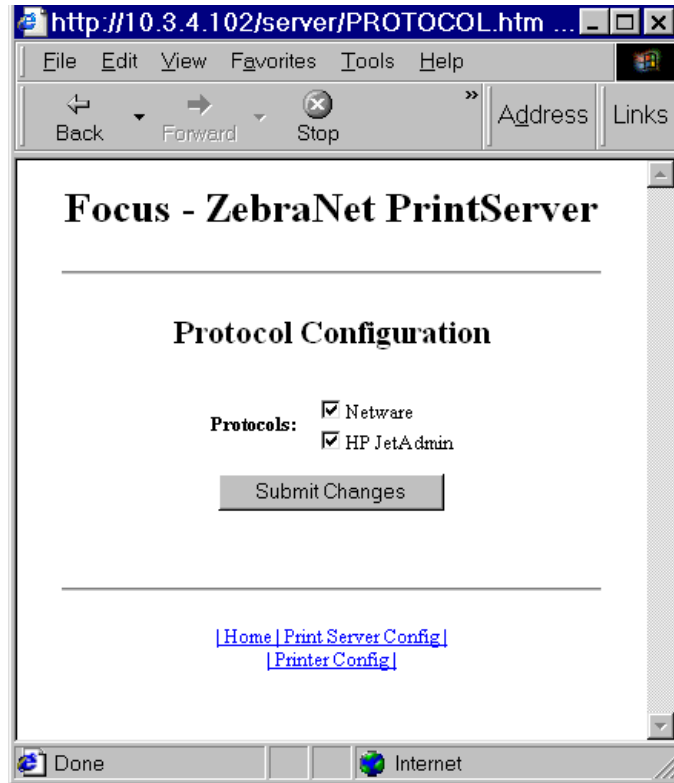

- Select the protocols you want to enable, then click **Submit Changes**.  
You get a confirmation to reset the unit for changes to take place.

## ZebraNet View

This section contains directions for accessing protocols using ZebraNet View.

### To enable protocols using WebView, complete these steps:

1. From the task bar, select Start>Programs>ZebraNet Utilities>ZebraNet View.

The *ZebraNet View* dialog opens:

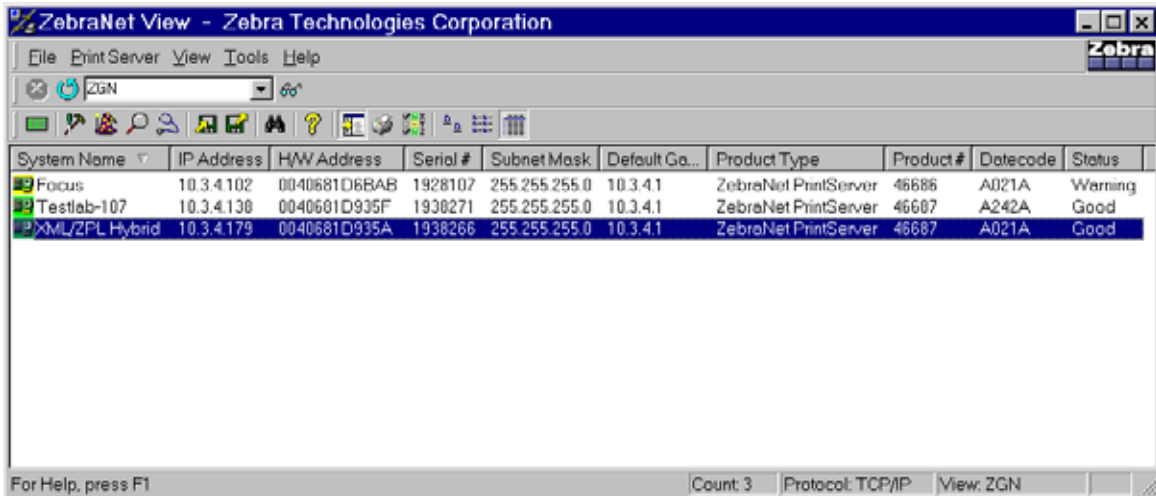

2. From the menu bar, select Print Server>Configuration.

3. Click the *Protocols* tab.

The *Protocols* tab opens:

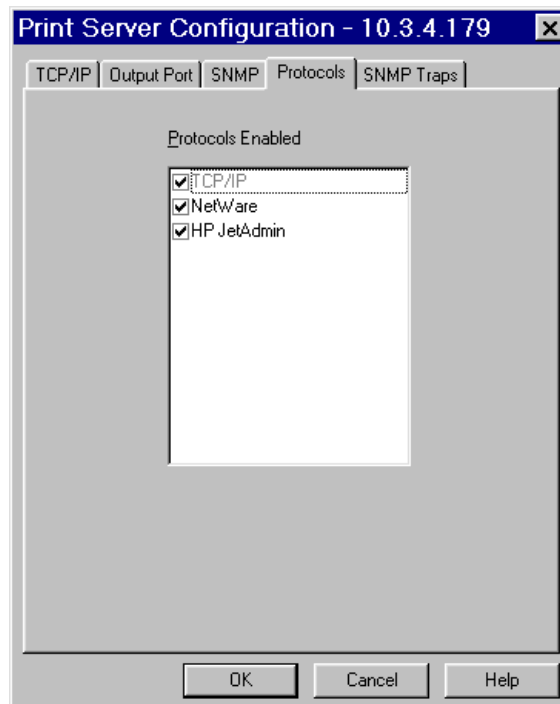

4. Select the protocols you want to enable, then click OK.  
A confirmation message opens.
5. To accept changes, click OK.

## Defaulting the PSII

This section provides you with instructions for defaulting the PSII to factory settings using WebView, ZebraNet View, and the Test button.

### WebView

To default the PSII to factory settings using WebView, complete these steps:

1. From the *ZebraNet PrintServer* view, click **Factory Print Server Settings**.  
The *Restore to Factory Defaults* page opens:

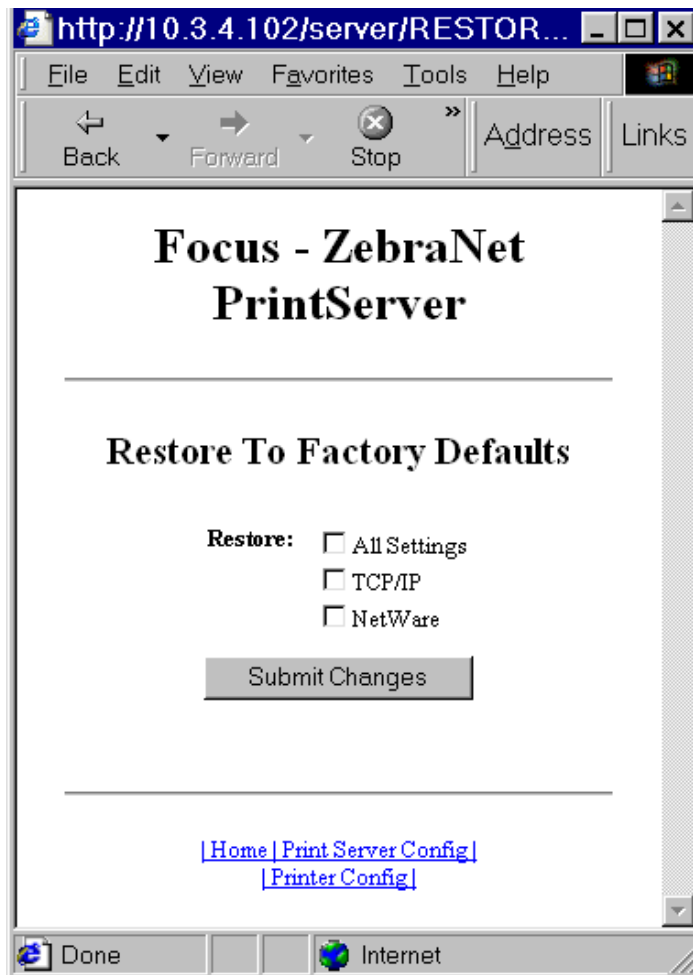

2. Enable the check box of the settings you want to reset, and click Submit Changes.



**Important** • With the reset command on its way to the PSII, the HTTP connection is unavailable while the PSII re-initializes. You need to wait a few seconds before trying to reestablish a connection.

## ZebraNet View

To default PSII to factory settings using ZebraNet View, complete these steps:

1. From the task bar, select Start>Programs>ZebraNet Utilities>ZebraNet View.

The *ZebraNet View* dialog opens:

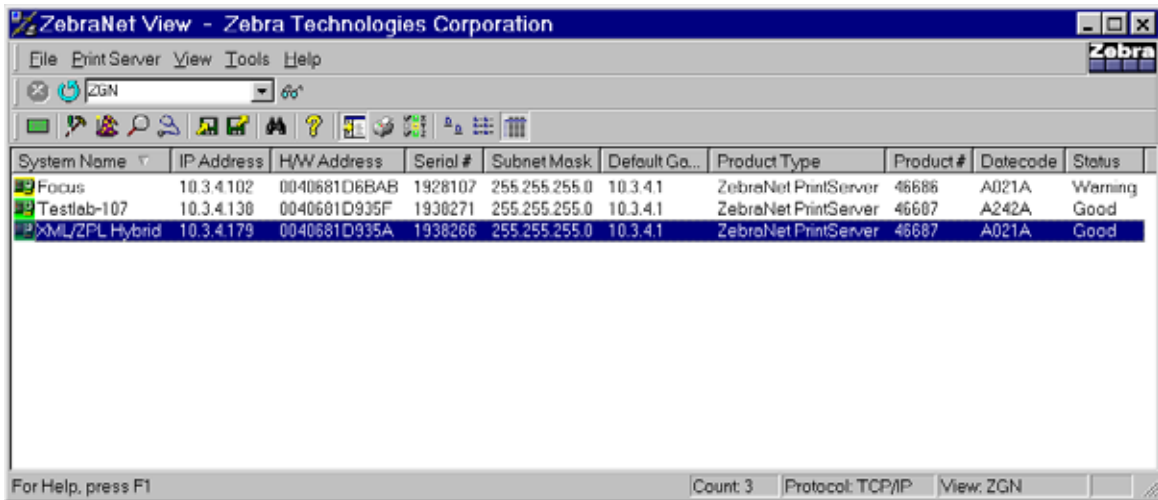

2. From the menu bar, select Print Server>Reset.

The *Reset Print Server* dialog opens:

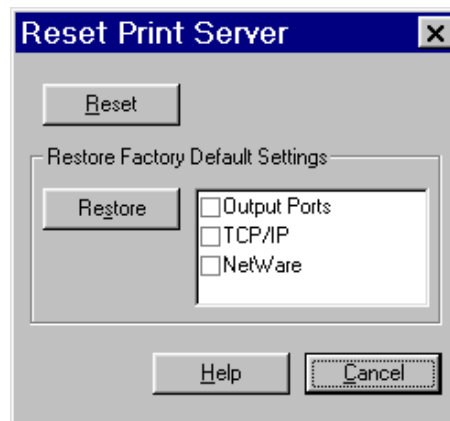

3. Select the settings you want to reset, then click Restore.

## Test Button

**To default the PSII to factory settings using the Test button, complete these steps:**

1. The printer is turned off **(O)**.  
The Test button is a small hole on the bottom of the external PSII device. To press the Test button, you need to insert something small into the hole, like a paperclip.
2. With the printer turned off, press and hold the Test button on the PSII device and turn on the printer.
3. The status indicator tells you when PSII has been reset to factory defaults, as follows:
  - If an active network cable is connected to the PSII, the status indicator turns solid green. When this happens, you can release the Test button.
  - If there is **not** an active network cable connected to the PSII, the status indicator flashes green. When this happens, you can release the Test button.
  - For more details on status indicators, see *Status Indicator on page 130*.



---

# Printing Configurations

This chapter provides information and instructions on configuring your printer.

## Contents

BSD (Berkeley Software Distribution)-Style Print Queue . . . . .	74
Configuring the Print Queue . . . . .	74
System V Queue Installation . . . . .	75
Configuring Operating System V Queue for ZebraNet Printing . . . . .	75
Prerequisites . . . . .	75
UNIX Configuration . . . . .	75

## BSD (Berkeley Software Distribution)-Style Print Queue

BSD is a version of the UNIX OS that distributes software that includes TCP/IP.

### Configuring the Print Queue

For remote BSD-style LPD printing, add the PSII as a remote printer in the `/etc/printcap` database to each host printing to the PSII. You can add printcap options as needed. If you are unfamiliar with these options, consult the printer documentation.



**Important** • You must be logged in as root.

The entry looks similar to this:

```
local_print_queue_name|[printer_model_and_manufacturer]:\  
:lp=:mx#0:rm=ZebraNet_name:\  
:rp=remote_print_queue_name:\  
:sd=path_to_spool_directory:lf=just log_file_name
```

`local_print_queue_name` — This defines the name of the printcap entry. It is used by the LPR/LPD utilities to specify which printcap entry is being referenced. Additional printcap entries can be added as needed for different queue types. Each entry must have a unique `local_print_queue_name` and a different spool directory to work properly. When you are ready to print, use the `local_print_queue_name` that matches the data type of the file to be printed.

`ZebraNet_name` — This is the name (alias) of the ZebraNet PSII. This must be the same name as entered in the `/etc/hosts` file or your NIS or DNS system. An IP address may also be used here.

`remote_print_queue_name` — This entry determines the ZebraNet port where the print job will be printed and optionally specifies ASCII printing that must end for LF1.

`path_to_spool_directory` — This is the path to a directory where the print jobs will be spooled for this queue. You must create a unique spool directory for each printcap entry.

`log_file_name` — This is the path to a file where error information from the LPD will be logged.



**Example** • Your printcap entries might look similar to this:

```
Ascii_files|form.feed.Queue_on_Port_1:\  
:lp=:mx#0:rm=pserver1:rp=MYQUEUELF1:\  
:sd=/usr/spool/myqueueelf1:\  
:lf=/usr/spool/myqueueelf1/queue.log
```



**Important** • Each printcap entry must have a different spool directory to work properly.



## System V Queue Installation

### Configuring Operating System V Queue for ZebraNet Printing

This section describes the configuration of the printing system on the UNIX operating system. For clarity and brevity, the following specific names are used to represent general devices or concepts.

`lj4` — The local queue name on the UNIX system to which you want PSII print jobs directed.

`ZEBRAPRINTER` — The host name or IP address of the remote system that is the PSII device. For example, to Telnet to the PSII and invoke the PSII configuration utility, you would enter:

```
Telnet ZEBRAPRINTER
```

A host name is not required for the PSII — the IP address can be used.

`yourqueuename` — This is the name of the queue on the ZebraNet and must end with `LF1`.

### Prerequisites

Before you proceed, the following prerequisites must be met:

- The name `ZEBRAPRINTER` and the IP address assigned to the PSII are in the `/etc/hosts` file on the UNIX system.
- The LPD must be running on the UNIX system.

### UNIX Configuration

**To configure the UNIX machine so users can spool print jobs to the PCL print queue on the ZebraNet named `ZEBRAPRINTER`, complete these steps:**

1. Log in to the UNIX machine as root.
2. Type:
 

```
lpsystem -t bsd ZEBRAPRINTER
```
3. Type:
 

```
lpadmin -p lj4 -s ZEBRAPRINTER!yourqueuename - I any
```
4. Type:
 

```
accept lj4
```
5. Type:
 

```
enable lj4
```
6. Try printing by typing the command:
 

```
lp -d lj4 [filename]
```



**Notes •** \_\_\_\_\_

\_\_\_\_\_

\_\_\_\_\_

\_\_\_\_\_

\_\_\_\_\_

\_\_\_\_\_

\_\_\_\_\_

\_\_\_\_\_

\_\_\_\_\_

\_\_\_\_\_

\_\_\_\_\_



---

# NetWare Print Configuration

This chapter provides you with instructions for configuring Novell's NetWare for printing to PSII.

## **Contents**

Printing in PServer Mode .....	78
--------------------------------	----

## Printing in PServer Mode

You *must* have Zebra's snap-in for Novell installed to complete these steps.

### To configure in Novell's NetWare for printing to the PSII, complete these steps:



**Important** • Some important items to keep in mind before you proceed with these steps:

- You must have PSII installed before you proceed with these steps.
  - Snap-in for Novell only works with Windows 9X operating systems.
1. From the task bar, select **Start>Programs>ZebraNet Utilities>ZebraNet View**.
  2. Create a ZebraNet object by completing the following steps:
    - From Novell's NetWare Administrator, select the container in which you want the object created.



**Example** • To create an object that is subordinate to sales, choose SALES.

- From the menu bar, select **Object>Create**.

If the Create option is gray, you do not have sufficient rights, or you selected a leaf object.

- Find *Zebra Print Server*, select it, and click **OK**.

If the class of the object you want to create is not listed, you cannot create it in the container you selected.

- Define filter and sort devices for displaying a list of PSII devices to choose from, and click **OK**.
- Type in a name for the new PSII object, and click **Create**.

Wait for the print server to reset.

- (*optional*) To rename one of the PSII devices, select the one you want to rename, and click **Create**.

3. In the *Directory Tree*, find your object, and double-click.
4. Select **Assignments>Assign>New**.
5. Next to the *Context* text-box, click the *Directory Tree* icon, then double-click the browse arrow.
6. Find the *Contexts* container you want, and double-click.  
It auto-fills into the *Context* text-box.
7. Enter the printer name you want, and click **Create**.
8. Next to the *Print Queues* section, click **New**.
9. Next to the *Context* text-box, click the *Directory Tree*, and double-click the **Browse** arrow.
10. Select the Context you want.  
It auto-fills the text-box.

11. In the *Print Queue Name* text-box, type in the name you want.
12. Next to the *Print Queue Volume* text-box, click the *Directory Tree* icon.
13. Double-click the *Volume* you want, and click Create.  
 Your *Print Queue Name* is listed with the name of your *Context* as the extension.
14. Click OK, and then click OK again.  
 Wait for the print server to reset.
15. To refresh your Directory Tree, double-click on your context twice.  
 You now see the Object, Printer Name, and Print Queue that you created.

**To attach a generic text driver to print to the PSII configured in NetWare, complete these steps:**

1. On Add Printer double-click, and click Next.
2. Select Network Printer, and click Next.
3. Click Browse and click on the context.  
 You can see the queue and printer that you created.
4. Select the queue, and click OK.  
 The Network path (queue name) auto-fills.
5. Click Next.
6. Select Generic for Manufacturer of printer, and click Next.
7. Select *Keep Existing Driver*, and click Next.
8. Enter the printer name you want and click Next.
9. Select *No* for printing a Test Page, and click Finish.
10. From the *Printers* dialog, double-click on your new printer and set it as the default printer.
11. Open a text editor, create ZPL (Zebra Programming Language) file, and print.



**Notes •** \_\_\_\_\_

\_\_\_\_\_

\_\_\_\_\_

\_\_\_\_\_

\_\_\_\_\_

\_\_\_\_\_

\_\_\_\_\_

\_\_\_\_\_

\_\_\_\_\_

\_\_\_\_\_

\_\_\_\_\_



---

# Using Printing Protocols

In this chapter you are given steps to set up your PSII to support **Internet Printing Protocol (IPP)**. Also, an exercise is provided to experiment with **File Transfer Protocol (FTP)** support.

## Contents

IPP .....	82
FTP .....	83

## IPP



**Important** • You must have IPP support on your system.

IPP is an application-level protocol used for distributed printing over the Internet. Using IPP from any standard IPP client, you can transfer jobs to a printer that is connected to your ZebraNet PSII device and the Internet.



**Important** • IPP support is not available on all PSII printers. To be certain you are running the latest version of firmware, visit our Web site: [www.zebra.com](http://www.zebra.com)

### To set up your PSII to support IPP, complete these steps:

1. Open a browser.
2. Enter the PSII IPP URL as follows:

```
http://xxx.xxx.xxx.xxx:631/ipp/port1
```

xxx.xxx.xxx.xxx = the IP address of the PrintServer II device

:631 = a fixed value

/ipp = a fixed string designating IPP

/port1 = a fixed value



**Example** • Your address might look like this:

```
http:198.60.248.120:631/ipp/port1
```



**Note** • Because IPP does not have an official standard, usage depends entirely on the quality of the IPP client and server.



## FTP

Embedded within the PSII is an FTP server application that processes file transfers from a host computer to the printer.

If the printer is on a network, label formats can be generated and data can be transferred without setting up a print queue.

### To send information to the printer in a Windows environment, try this alternative exercise:

1. In a text editor, generate the following ZPL II code:

```
^XA
^FO100,100
^CF0,55^FDZebra Technologies^FS
^XZ
```

2. Save the file and name it `test.txt`.
3. Open the MS-DOS Command Prompt and type:  
`ftp <IP of PrintServer II>`



**Example** • If the IP address of your PSII device is 12.3.4.123, you would type:

```
ftp 12.3.4.123.
```

This opens a session with the FTP server.



**Note** • The default user name is blank.

4. Type your user name and press Enter.
5. Type:  
`put test.txt`  
This transfers `test.txt` to the printer, and the printer generates a label.
6. To terminate the FTP session, type:  
`quit`



# A



---

## PrintServer II

This appendix provides you with details on the PSII features that were not covered in the chapter *Getting Started* [on page 43](#).

### Contents

PSII Features . . . . .	86
Status and Configuration . . . . .	86
Print Server Status . . . . .	95
Reset . . . . .	97
Restore . . . . .	98

## PSII Features

This section covers features available for the PSII *only*, not the printer's features. Some of the features you access in this section prompt you to enter the default user ID and password, as follows:

- **User ID:** admin
- **Password:** 1234

The options on the **Print Server** page vary. ZPL and EPL printers print server settings vary slightly.



**Note** • The difference between ZPL and EPL is this:

- ZPL — If you have a ZPL printer, you are initially prompted to the Printer Home page, and from there, you select Print Server Settings.
- EPL — If you have an EPL printer, you are immediately prompted to the Print Server page.

## Status and Configuration

The steps that follow are based on the navigation of a ZPL printer using firmware X.10 or higher.



**Important** • You can upgrade your firmware by visiting our Web site:

<http://www.zebra.com>

**To access the print server settings, complete these steps:**

1. Open a Web browser.

2. In the *Address* text-box, type your printer's IP address, and press Enter.

The *Printer Home Page* opens:

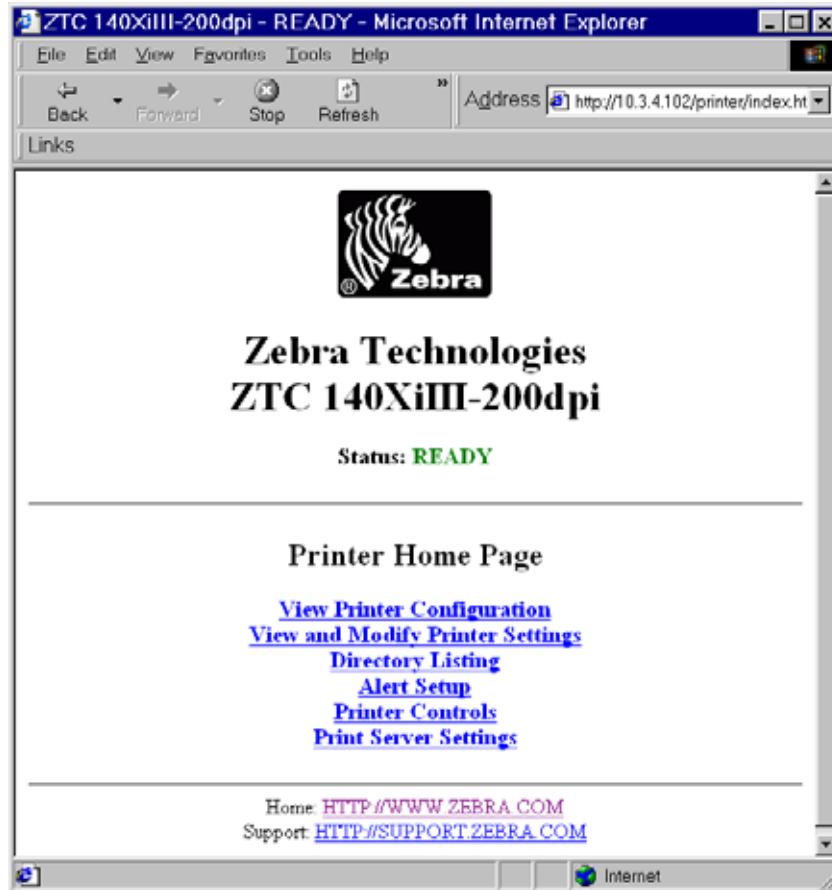

3. From the *Printer Home Page*, click **Print Server Settings**.



**Important** • The illustration of the Printer Server Settings page is based on a ZPL printer. If you have an EPL printer, the menu options on the Print Server page are slightly different.

The *PrintServer* page opens:

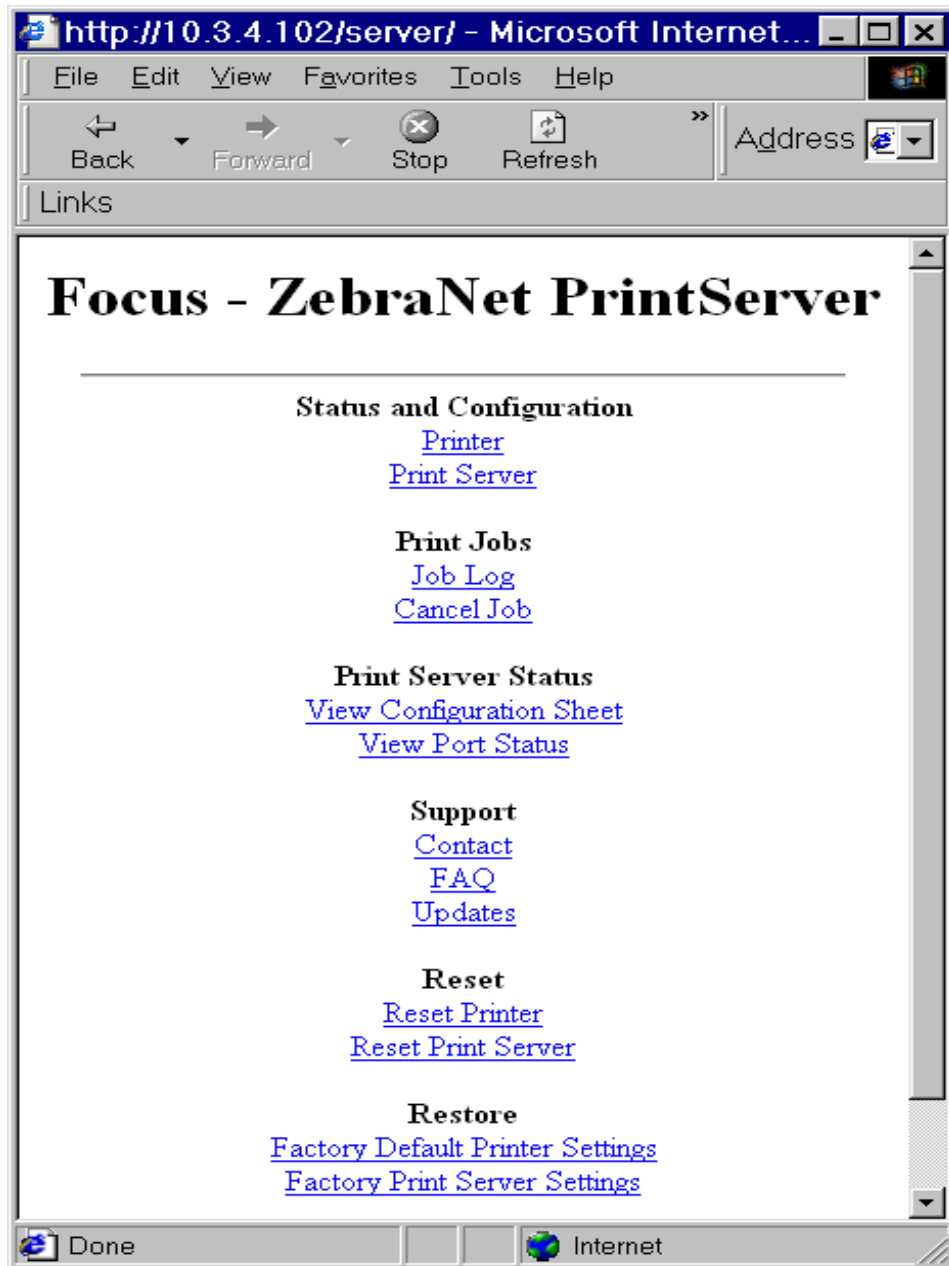

- From the *PrintServer* page, click **Print Server**.

The *Print Server Configuration* page opens:

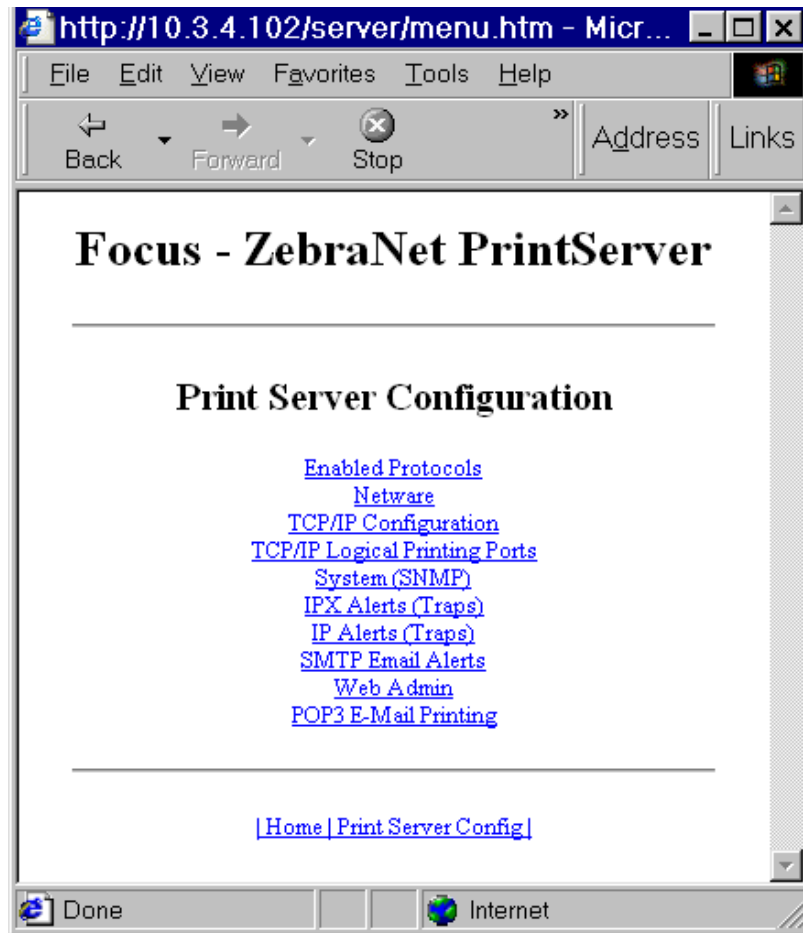

5. In the *Print Server Configuration* page, you have a menu to choose from. The table that follows identifies what each menu option page looks like:

**Enabled Protocols**

Modifies the protocols to be used. NetWare, HP JetAdmin, or both.

Enabling HP JetAdmin Support allows status from the Zebra device to display in Hewlett-Packard's HP JetAdmin utility.

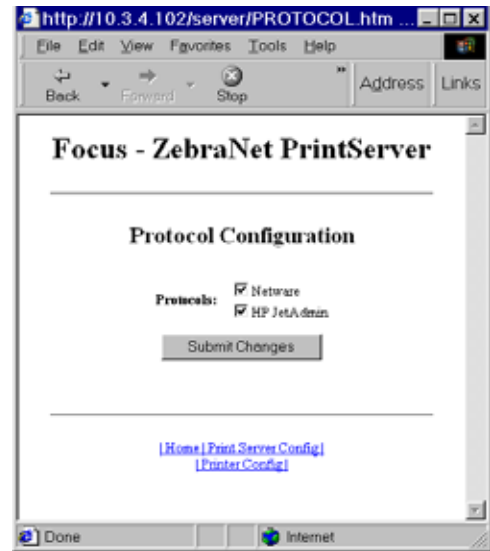

**Netware**

Preferred Tree — Enter the tree that the printer is in.

Print Server Name — Enter the name of the printer.

Disable NetWare SAP — Enables or disables the broadcast SAP (Service Advertising Protocol) messages. Typically, SAP is enabled. If SAPs are disabled, the print server does not appear in the bindery and is not discovered by ZebraNet View. Disabling SAPs reduces network traffic, however, SAPs should be disabled, only on networks using NDPS exclusively or NetWare 5 over the IP protocol.

NetWare Frame Format — You can select how the frames for the data packets are assembled. The default is Automatic Sensing.

For details, see Help.





### TCP/IP Configuration

You can change the TCP/IP Configuration of the PSII.

For details, see Help.

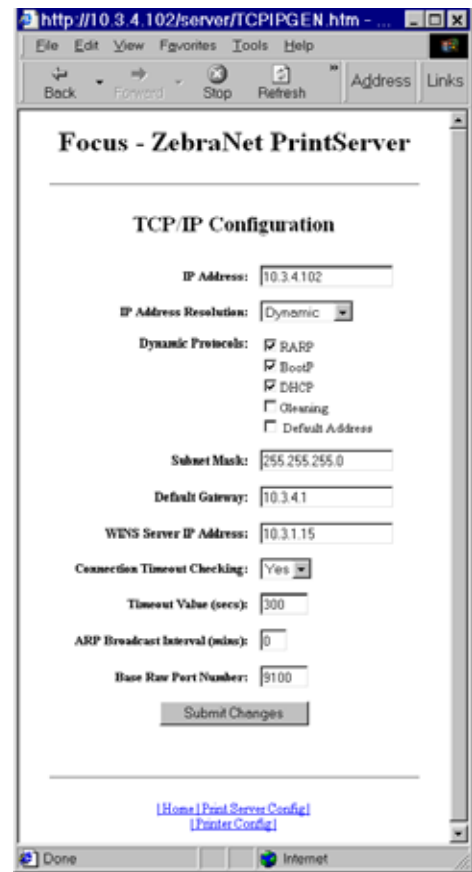

### TCP/IP Logical Printing Ports

Logical printers allow you to set up multiple pre- and post-processing configurations for each output port. Each logical port configuration can do the following:

- Add user-configured strings before and after the print data.
- Remove unwanted characters from the beginning of the print data.
- Four logical printer configurations are supported for each output port on the printer. The configurations can be assigned to any port, and all of these configurations can be assigned to a single output port.

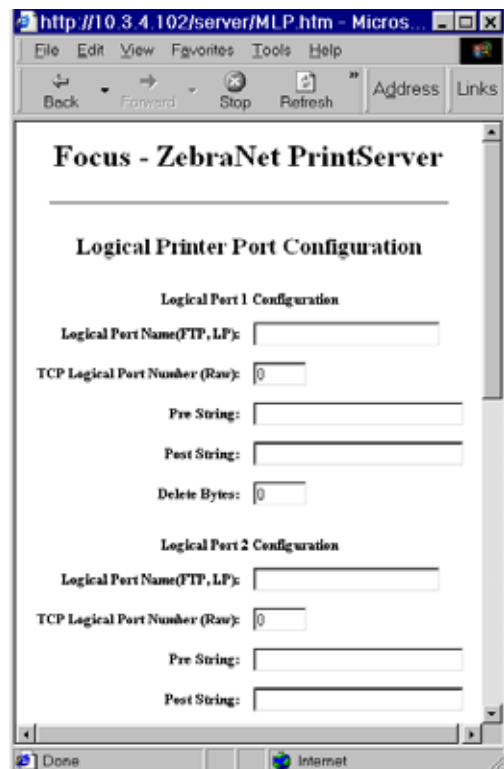

### System (SNMP)

This feature gives you the ability to manage multiple devices on a network, be it printers, computers, or other network-attached devices.

On this page you can define the SNMP system name, system location (PSII description), and other SNMP settings for your PSII.

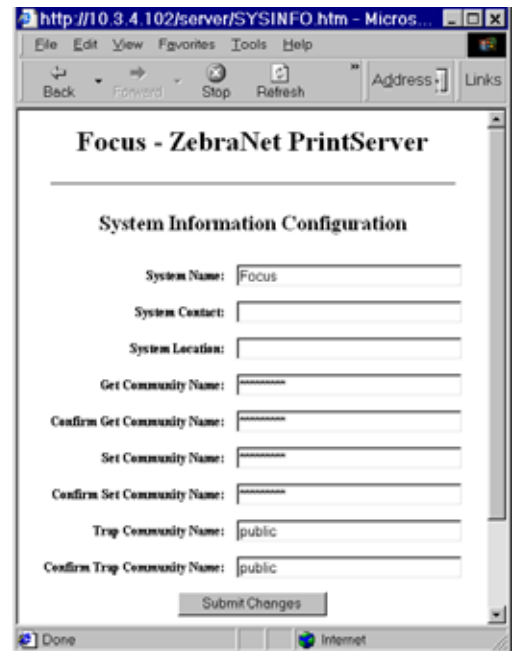

### IPX Alerts (Traps)

Internetwork Packet Exchange (IPX) is Netware's network-layer protocol that handles networking addressing, routing, and packets. This feature has you enter the IPX Network Address and IPX Node Address to which traps will be sent.

- To broadcast traps to all addresses on all networks, enter FFFFFFFF in the IPX Network address field and FFFFFFFFFF in the IPX Node Address field.
- To broadcast traps to all addresses on a specific local network, enter the network number in the IPX Network Address field and then FFFFFFFFFF in the IPX Node Address field.
- To disable traps, set all destination addresses to 0.

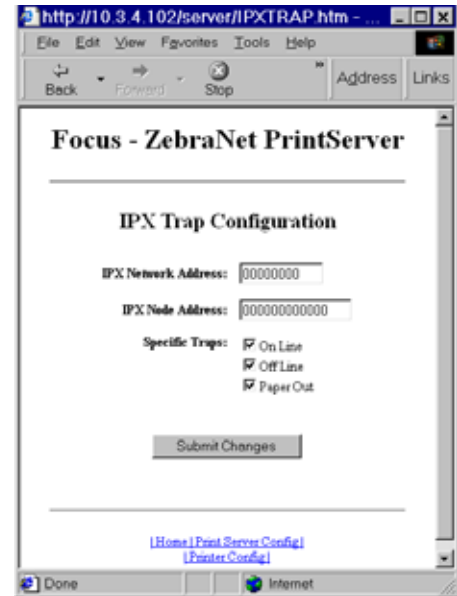

### SMTP Email Alert Configuration

This feature allows you to enter data regarding System Information on the network that is being used. Typically, a Network Administrator would use this.



### Web Admin

This page allows you to configure the Admin name and password. Links to upgrades and support information can also be altered.



### POP3 Email Printing

This feature helps you set up the print server to receive email messages containing formats that can be printed. The POP3 settings must be set to retrieve emails from the email server.

**Warning •** Setting the POP3 polling interval (seconds) below 30 can cause communication problems with the POP3 server.



## Print Server Status

From the *Print Server* page, in the **Print Server Status** section you can access PSII's configuration sheet and port status.

To open PSII's configuration sheet, complete this step:

1. From the *PrintServer* page, click **View Configuration Sheet**.

This page opens:

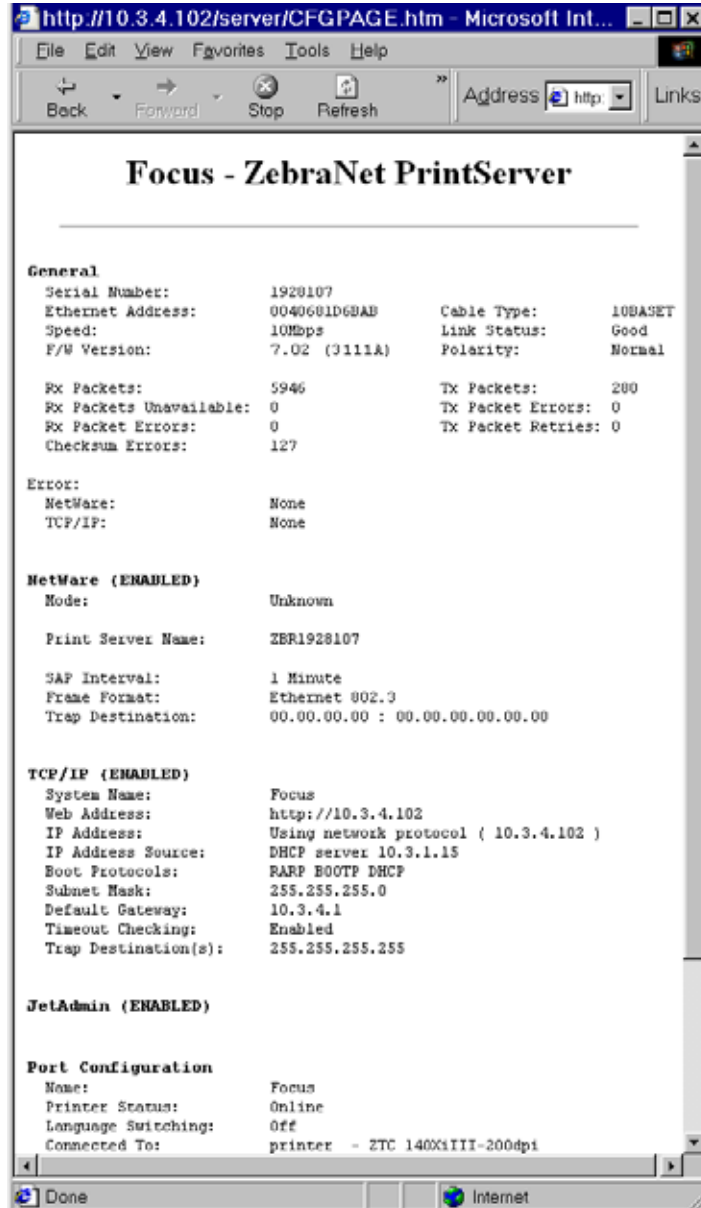

To view the port status, complete this step:



**Important** • The default user ID and password is required to access this page.

1. From the *Print Server* page, click **View Port Status**.

The port status page opens:

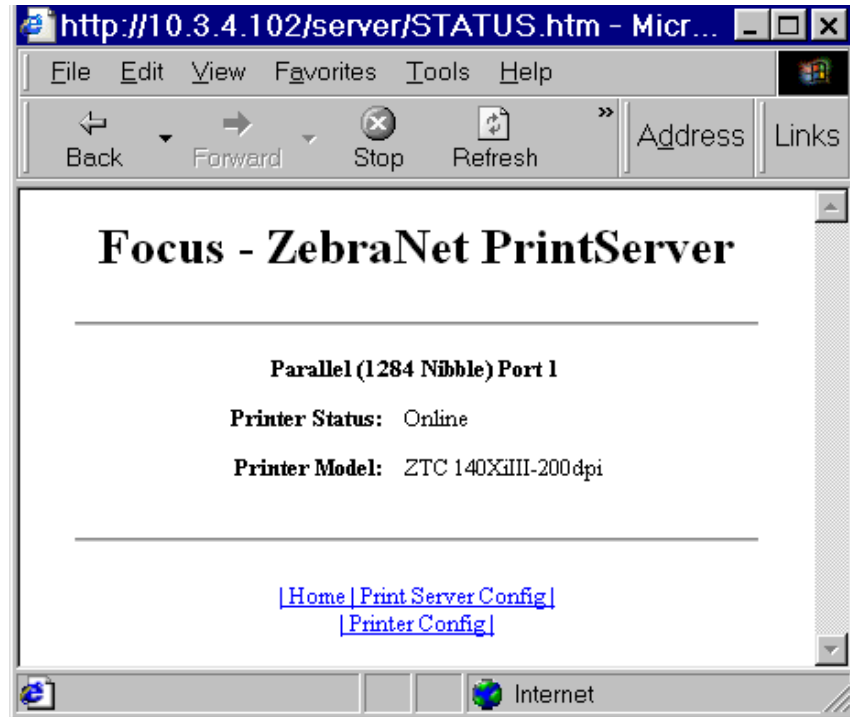

## Reset

From the *Print Server* page, in the **Reset** section you can reset PSII's configuration settings to what they were before you made the most recent changes.

### To reset the PSII, complete these steps:

1. From the *Print Server* page, click **Reset Print Server**.

The *Reset Device* page opens:

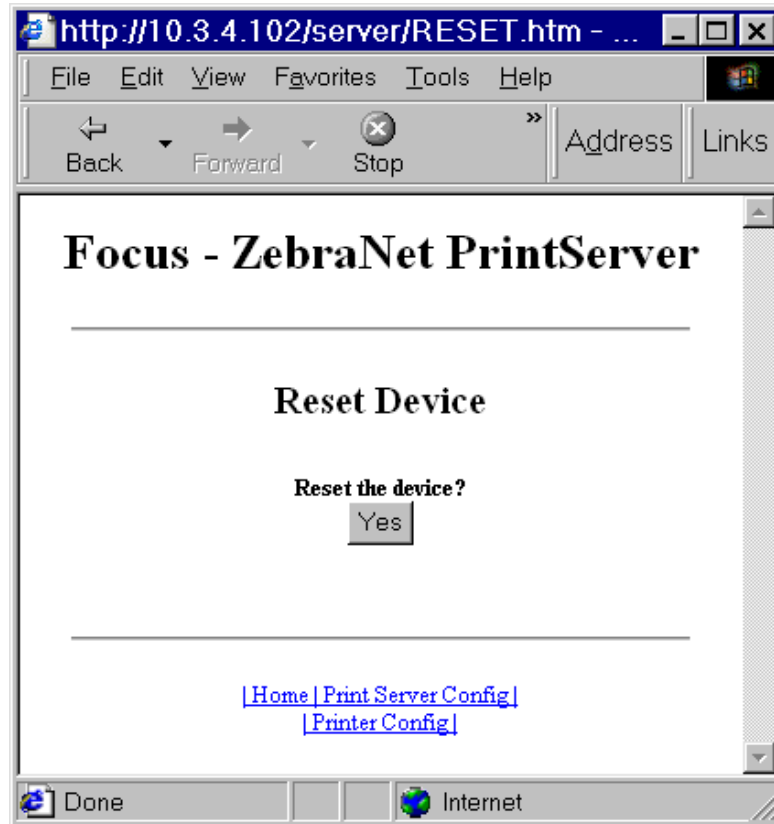

2. To reset PSII, click Yes.

## Restore

From the *Print Server* page, in the **Restore** section you can restore PSII's to the default factory settings:

**To restore PSII to the default factory settings, complete these steps:**

1. From the *Print Server* page, click **Factory Print Server Settings**.

The *Restore To Factory Defaults* page opens:

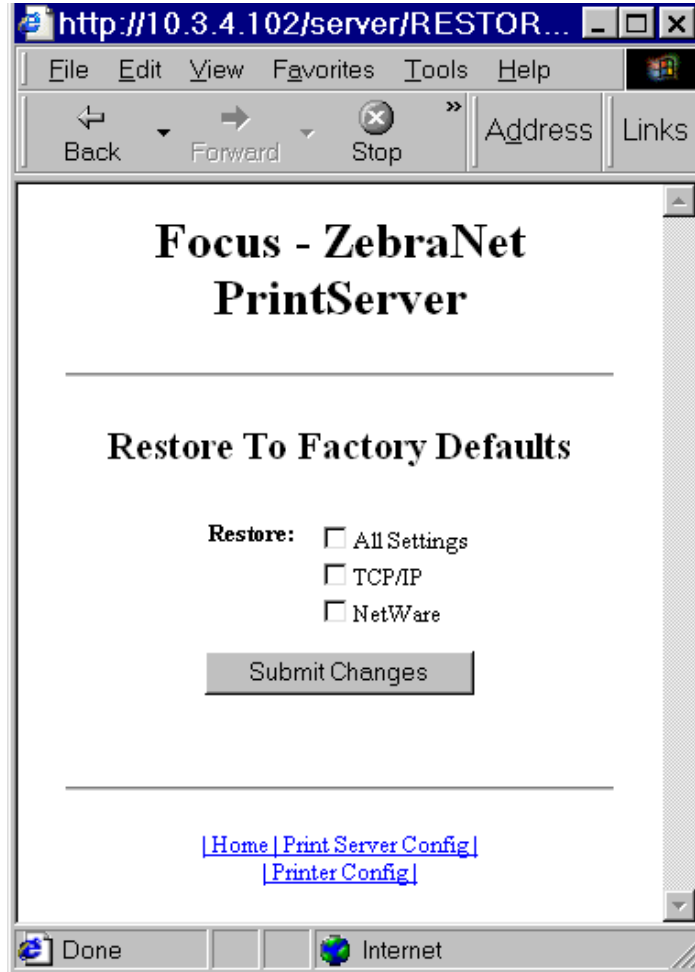

2. Make the selections you want, and click **Submit Changes**.



# B



---

## ZebraLink

The appendix provides you with detailed information that allows you to use the enhanced functionality of your ZebraLink-enabled printer with the PSII.

### **Contents**

WebView .....	100
Home Page .....	100
Alert Setup .....	109

## WebView

WebView gives the System Administrator or user who needs complete, easy, one-step control over the printing environment exactly what is needed. It provides real-time configuration, control, and monitoring capabilities with the convenient graphic interface of a Web browser.

The Web pages returned by Zebra printers are not static. They contain real-time information about the printer's present state of operation, including on-line status, error conditions, and all printing parameters.

## Home Page



**Note** • To access the printer's Web page, you need the IP address. For instructions on getting the IP address, see *Assigning an IP Address on page 46*.

The Home Page is the first Web page that opens. It is a page with a menu of hyperlinks. Each hyperlink allows you to make modifications to the printer, PSII, and network settings; the other changeable settings through the Home Page include:

- Network Status, Error, and Warning reports
- ZebraNet PSII configuration
- Printer settings
- Directories of objects stored in Flash memory and RAM devices
- Objects, stored fonts, images, programs, and ZPL II formats
- Zebra Technologies support and home pages

To open the WebView of your printer, complete these steps:

1. Open a Web browser.
2. In the *Address* text-box, type your printer's IP address, and press Enter.

The *Printer Home Page* opens:

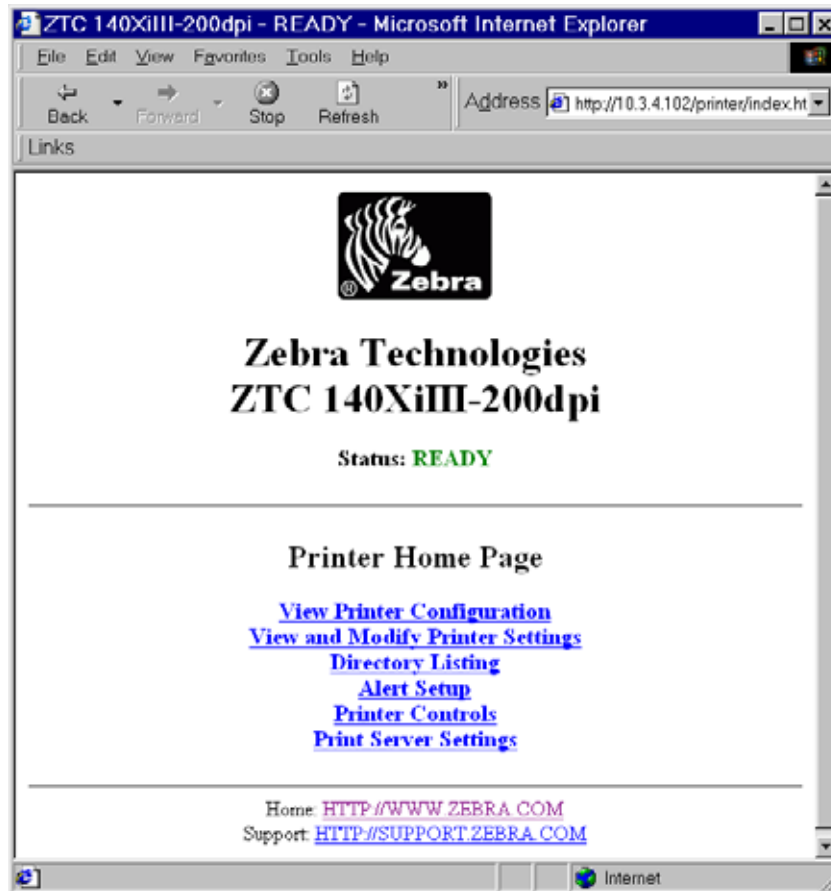

## View Printer Configuration

The View Printer Configuration menu option provides accurate, up-to-the-minute information on the printer's current state. An administrator can conveniently find any information on the Virtual Configuration Label and also check on the status of printer ports.

**To see the View Printer Configuration menu option, complete these steps:**

1. From the *Printer Home Page*, click **View Printer Configuration**.

The WebView displays the configuration settings:

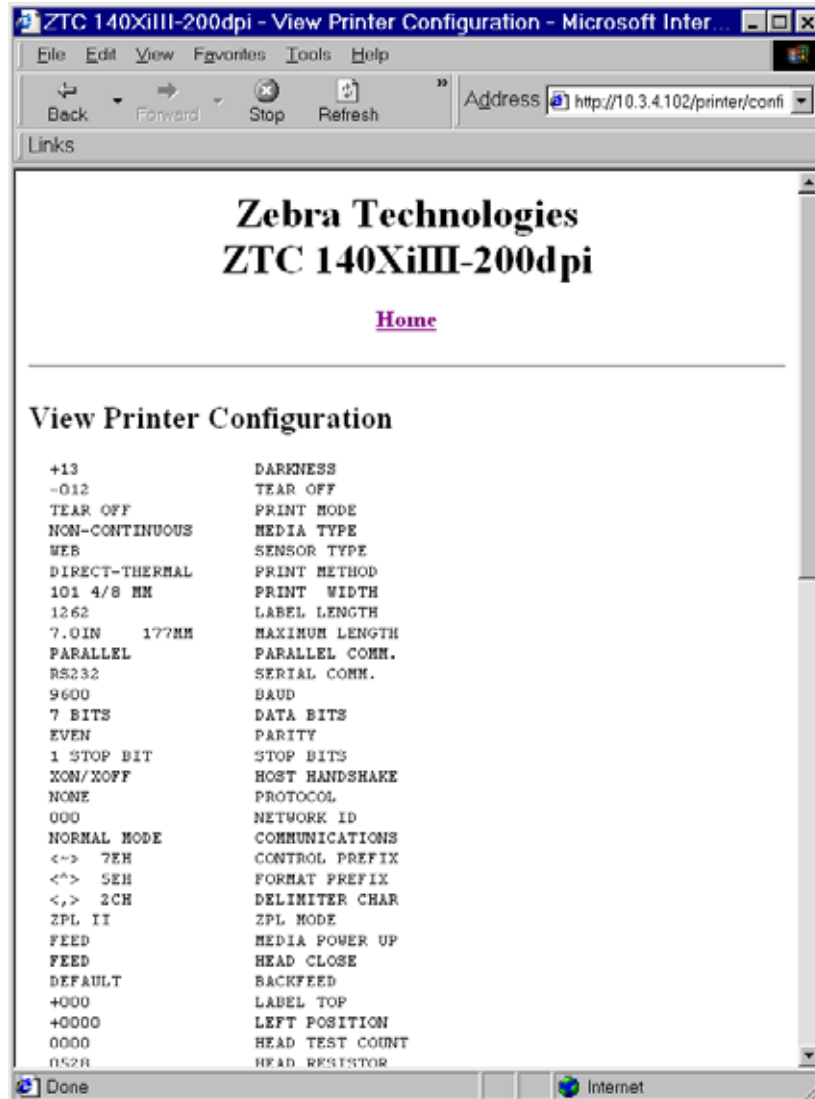

2. To update the printer information from this view:
  - For Netscape, select Reload and the printer sends current information to the Web browser.
  - For IE, click Refresh and the printer sends current information to the Web browser.

- When you are finished reviewing:
  - To return to the Home page, click the **Home** link.
  - To print the label, scroll to the bottom of this page and click Print Label.

## View and Modify Printer Settings

This section provides you with steps for accessing and modifying printer settings with a ZebraLink-enabled printer. It also provides illustrations of the various pages you can access.



**Important** • To apply changes made in this section, you need to use the default user ID and password:

User ID: admin

Password: 1234

### To view the View and Modify Printer Settings, complete these steps:

- From the *Printer Home Page*, click **View and Modify Printer Settings**.

The *View and Modify Printer Settings* page opens:

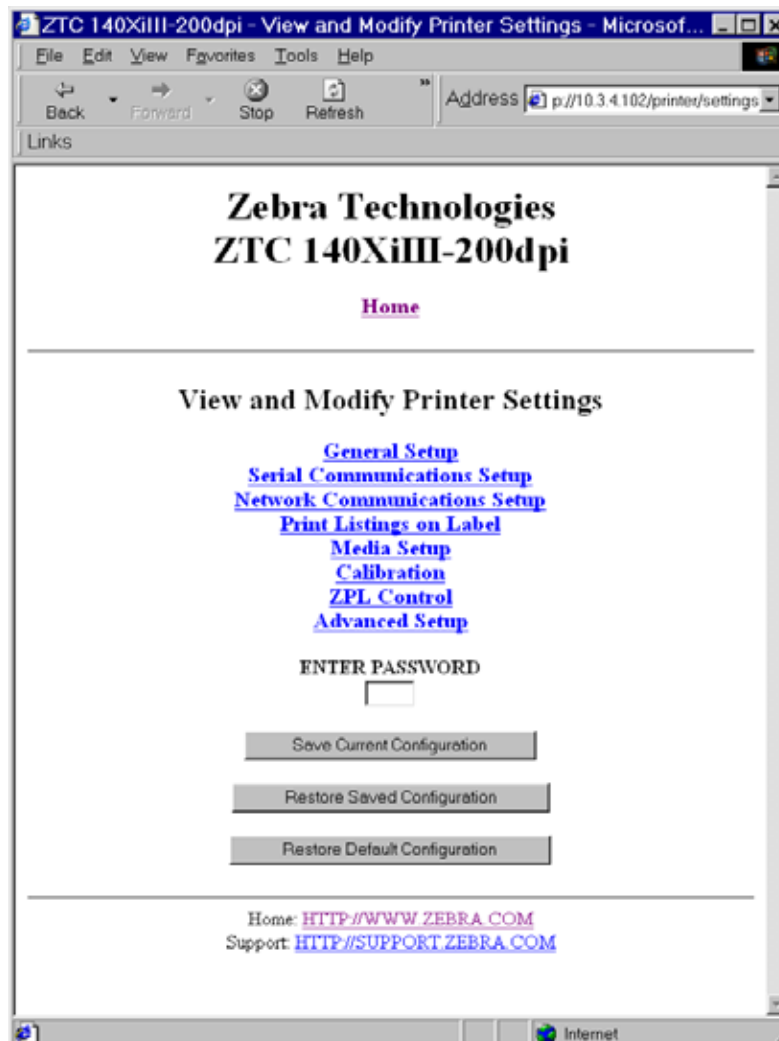

2. In the View and Modify Printer Settings page, you have a menu to choose from. The section that follows identifies what each menu option page looks like:

General Setup

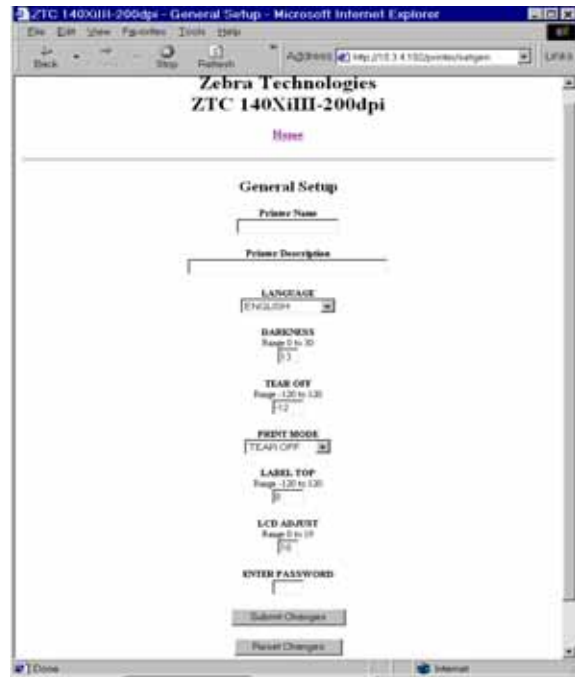

Serial Communications Setup



Network Communications  
 Setup



Print Listings on Label



Media Setup



Calibration





ZPL Control



Advanced Setup



## Directory Listing

The directory page provides a listing of all file system devices (B:, E:, R:, Z:). The size, name, and location of each stored object appears.

Buttons are available to perform file management operations on the objects. The file management operations include:

- Delete object — Not available for objects in read-only memory (Z:).
- Copy object to a new name and/or device — Not available for objects in read-only memory (Z:).

### To view the Directory Listing, complete these steps:

1. From the *Printer Home Page*, click **Directory Listing**.

This page opens:

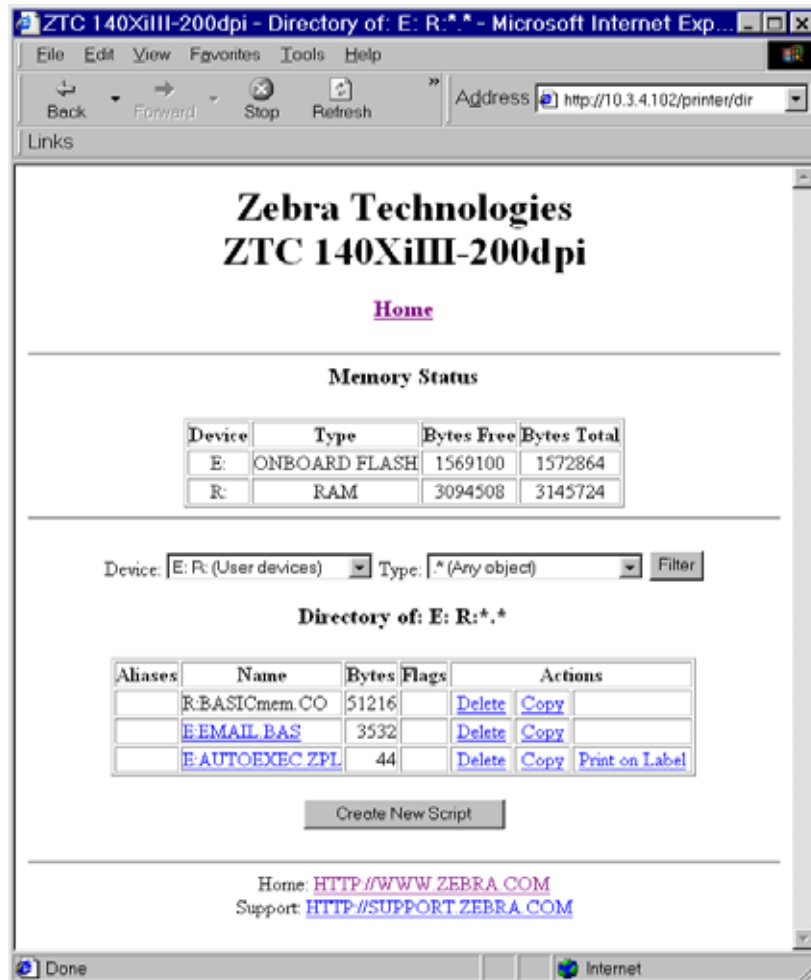

2. There are several links to select in this view.
3. To create a script, click **Create New Script**.

## Alert Setup

To configure the printer's interaction with ZebraNet Alert to be completely functional, SNMP settings must be established in these areas:

- The printer, via the WebView interface.
- The Alert Printer Management Utility for logging SNMP traps.

The ZebraLink messaging system provides for more than SNMP notification. Alert can be routed to various destinations:

- TCP
- UDP
- email
- serial port
- parallel port destinations

### To view Alert Setup, complete these steps:

1. From the *Printer Home Page*, click **Alert Setup**.

The *Alert Messaging System* page opens:

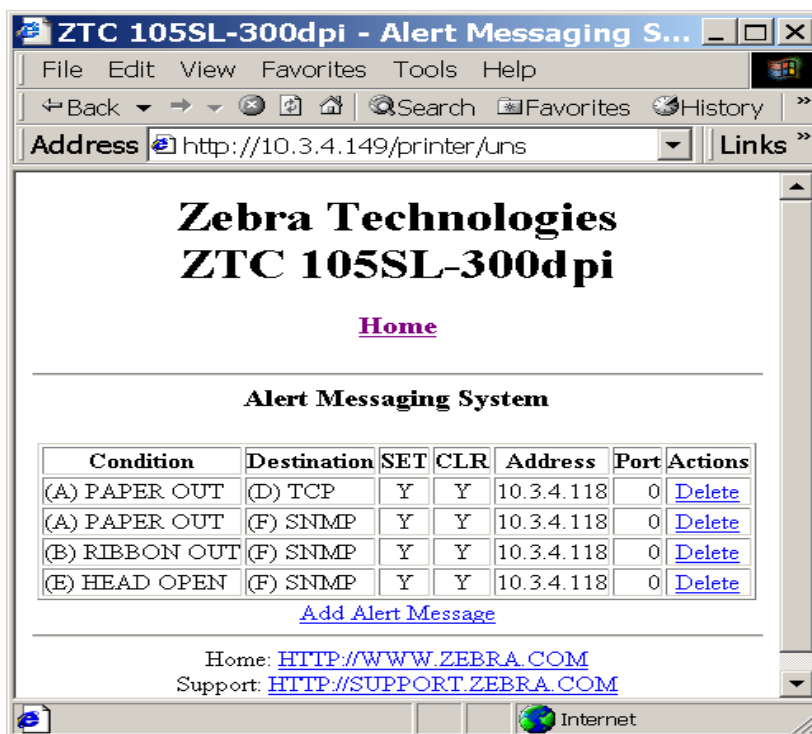

2. To add an alert, click **Add Alert Message**.
3. Select accordingly.

## Establishing Email Alert Messaging

ZebraNet Alert supports email notification of printer errors sent directly to any valid email address. You can have multiple email addresses set up for routing different error messages, or split notifications between email and other network management tools.

### To begin receiving email notification of errors, complete these steps:

1. From the browser, in the address text-box type in the printer's address.  
The printer's home page opens.
2. From the *Printer Home Page*, click **Alert Setup**.  
The Alert Setup page shows a list of message notifications and their respective destinations.
3. From the *Alert Setup* page, email notification can be set up. Click **Add Alert Message**.

The *Add Alert Message* page opens:

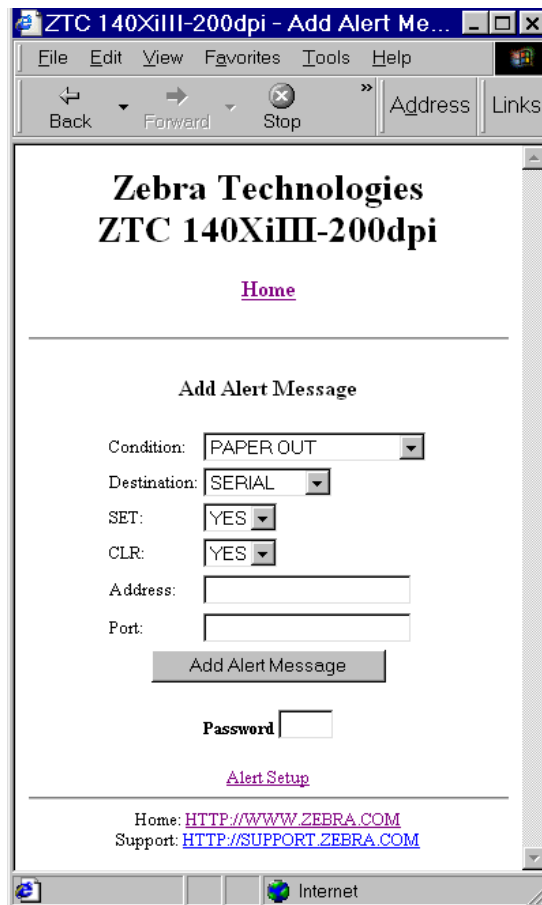

**Important** • The printer accepts only the last configuration made.

4. Specify the condition to send over email, such as **HEAD ELEMENT BAD** or **PAPER OUT**.
5. Enter a valid email address for the messages to be sent.



**Example** • admin@yourcompany.net (The Port field can be ignored for email setup.)



**Important** • You must type in a password. If you forget to enter the default password, the alerts you just set are deleted.

6. Click **Add Alert Message**. Here you can continue to add more settings or, if finished, save the current settings.
7. From the Printer Home Page, select **PrintServer Settings>Network Communications Setup**.
8. Click **SMTP Email Alerts**.
9. Specify your SMTP server address.

When these steps are done, you can begin receiving email notification messages.

## Printer Controls

This page offers control over basic printer functions.

Other functions are also accessible from this page. These include:

- Feed — causes printer to feed one label.
- Cancel One Format — cancels the currently printing format.
- Cancel All Formats — cancels all formats.
- Reset Printer — causes printer to perform its standard reset without cycling power.

### To view Printer Controls, complete these steps:

1. From the *Printer Home Page*, click **Printer Controls**.

This *Printer Controls* page opens:

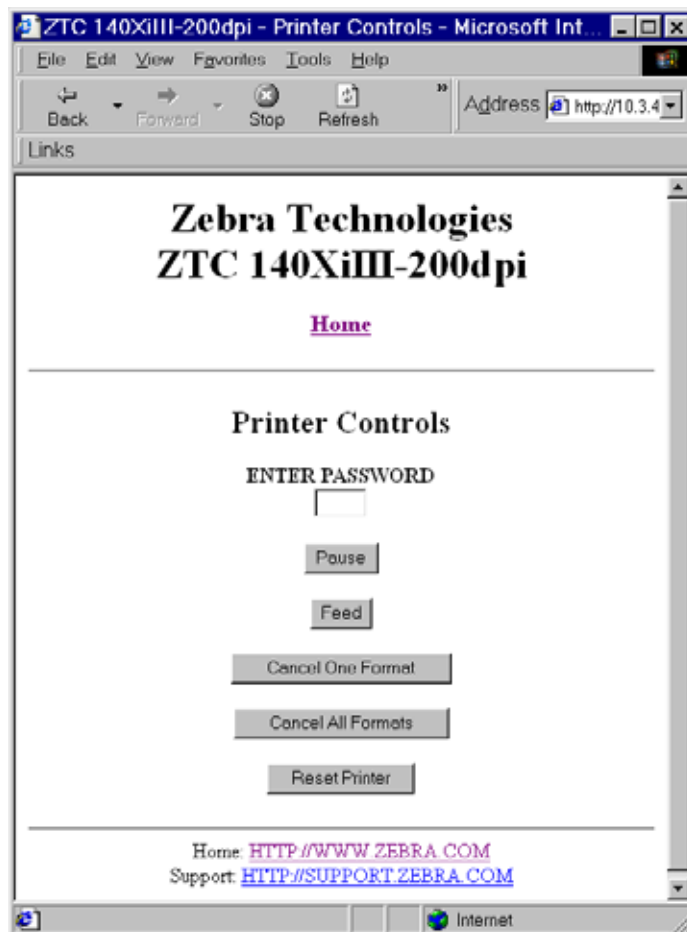

**Important** • In this view, you must have administrative rights to make changes to the printer controls.

## Print Server Settings

This section provides you with instructions for viewing the current printer settings.

### To view the print server menu, complete these steps:

- From the *Printer Home Page*, click **Print Server Settings**.

The *PrintServer* page opens:

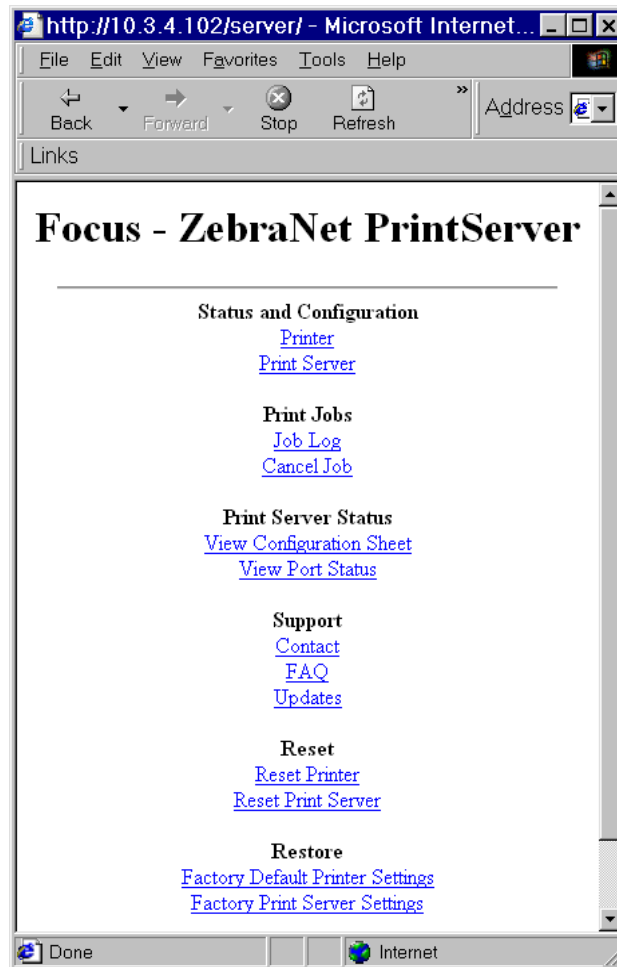

For more details on PSII, see *PrintServer II* on page 85.



Notes • \_\_\_\_\_

---

---

---

---

---

---

---

---

---

---

---

---





---

# ZebraNet Utilities

The appendix provides you with details on ZebraNet Utilities, the software suite of printer administration tools that complements and enhances both ZebraLink and the ZebraNet family of connectivity products.

## Contents

ZebraNet View .....	116
ZebraNet Alert .....	119
PSII Alerts .....	119
ZebraLink Alerts .....	119
ZebraNet Alert Using SNMP .....	120
Sending Email to Your Zebra Printer .....	121
Open Alert .....	125
ZebraNet Connect .....	125
ZebraNet View Java Applet .....	126

## ZebraNet View

ZebraNet View allows you to locate printers automatically. It can search on parameters such as IP address, subnet, printer model, printer status, and many other user-defined characteristics. It also offers powerful device management capabilities.

### To open ZebraNet View Utilities, complete these steps:

1. From the task bar, select Start>Programs>ZebraNet Utilities>ZebraNet View.

The *ZebraNet View* dialog opens:

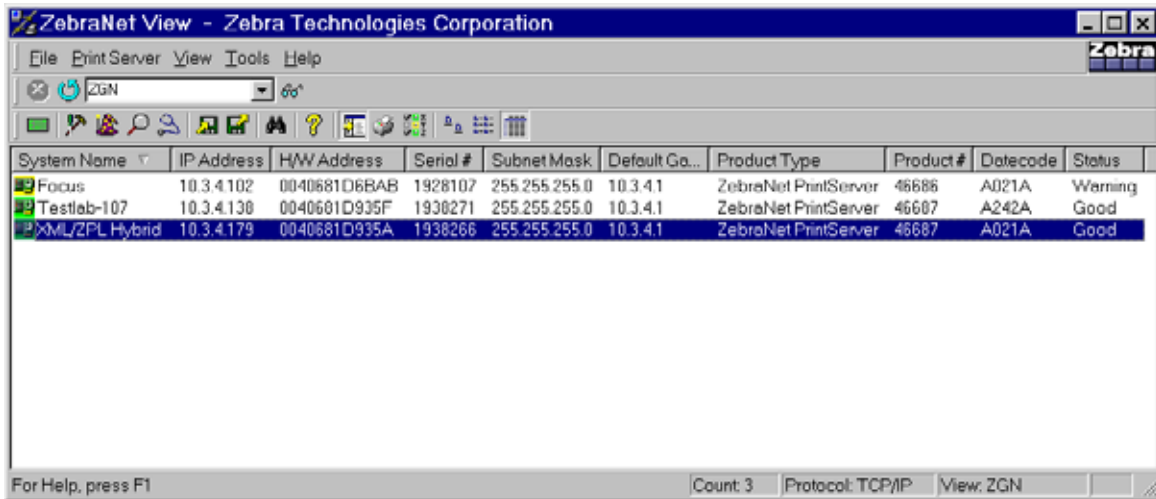

2. Select your printer.

3. From the menu bar, select PrintServer>Configuration.

The *Print Server Configuration* dialog opens:

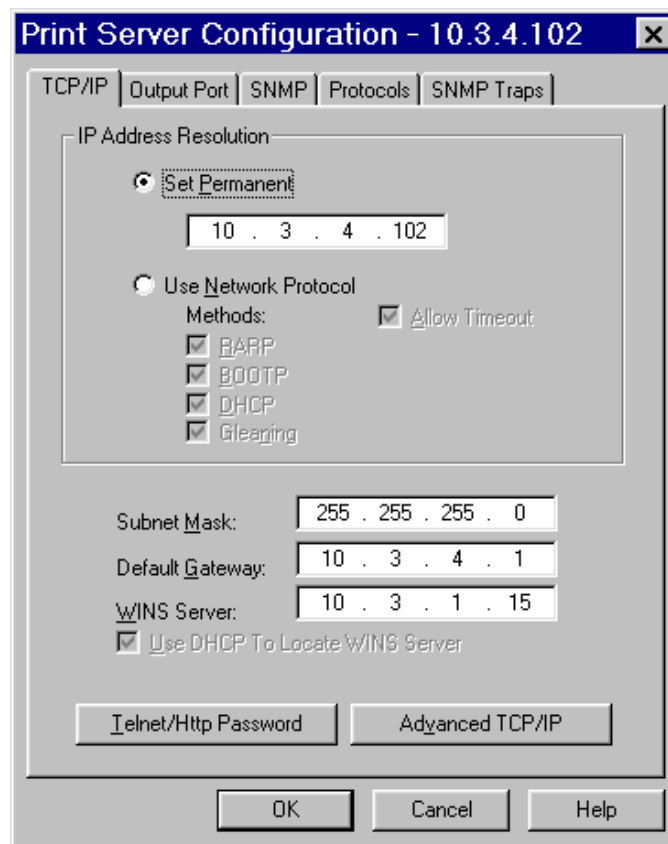

There are multiple tabs that you can access to make changes to current settings.

**To set alerts in ZebraNet View, complete these steps:**

1. From the *Print Server Configuration* dialog, click the *SNMP Traps* tab.  
The *SNMP Traps* tab shows the alerts you can set.

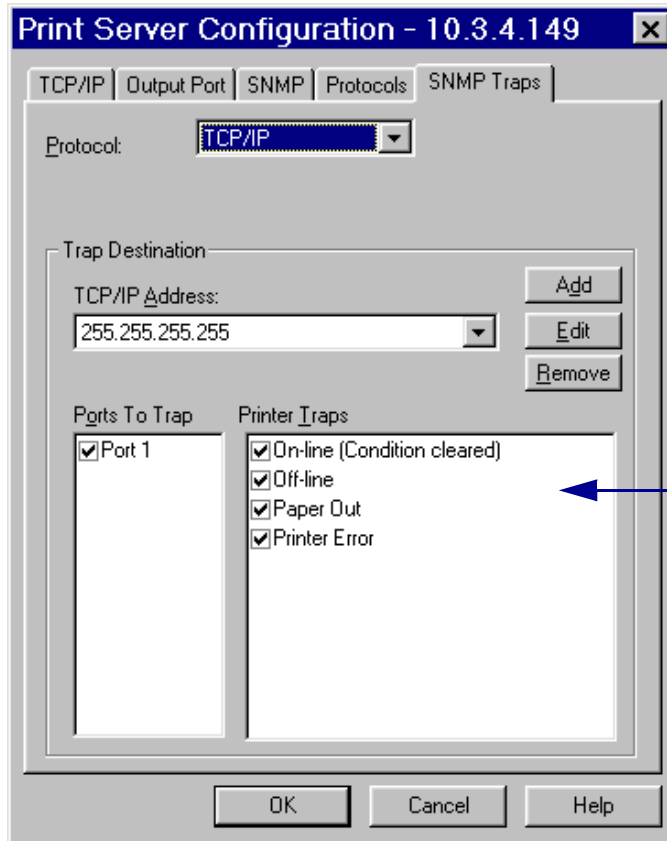

The check boxes in Printer Traps are the alerts.

2. To monitor the set alerts (printer traps), see *ZebraNet Alert* on page 119.

## ZebraNet Alert

ZebraNet Alert gives you the ability to manage your Zebra printers by immediately notifying System Administrators of printer error or warning conditions. Using Web- based configuration tools, selected errors or warning conditions can be routed to a variety of services such as email messages, wireless pagers, or the ZebraNet Alert.

The following tables show the conditions that can trigger alerts:

### PSII Alerts

These conditions can trigger PSII alerts:

- On-line (condition clear)
- Off-line
- Paper out
- Printer error

### ZebraLink Alerts

These conditions can trigger ZebraLink Alerts:

- Media out
- Ribbon out
- Printhead over-temp warning
- Printhead under-temp warning
- Head open
- Power supply over-temp
- Ribbon warning (in direct-thermal mode)
- Rewind full
- Cut error
- Printer paused
- PQ job completed
- Label taken
- Head element out
- Power on

## ZebraNet Alert Destinations

Unsolicited Alert messages can be directed to the following destinations:

- Email (PSII-specific)
- Serial (ZebraLink-specific)
- Parallel (ZebraLink-specific)
- TCP (PSII-specific)
- UDP (ZebraLink-specific)
- SNMP (PSII-specific)

## ZebraNet Alert Using SNMP

You can send notifications over SNMP only, for use with ZebraNet Alert or a similar network management utility.

**To configure the PSII to send alerts across a TCP/IP Network to ZebraNet Alert, complete these steps:**



**Important** • If you did not install ZebraNet Alert during the ZebraNet Utilities installation, see *ZebraNet Utilities on page 37*.

1. From the task bar, select Start>Programs>ZebraNet Utilities>ZebraNet View.
2. Select the printer you want.
  - If a DHCP server is present, the PSII will already have an IP address.
  - If no DHCP server is present, you might need to assign the printer an IP address.
3. To assign your printer an IP address, from the menu bar, select Print Server>Configuration.
4. For PrintServer SNMP Traps, select the *SNMP Traps* tab.
5. Enter the trap destination and options.

This tells the PSII what TCP/IP address to send the alerts to, and under what circumstances to send error and log reports. Entering 255.255.255.255 broadcasts the message to every host on the network with an SNMP program running.

6. For ZebraNet Alert to get and display the messages, you need to open ZebraNet Alert. To do this, follow these steps:

- From the task bar, select **Start>Programs>ZebraNet Utilities>ZebraNet Alert**.



**Important** • The SNMP trap settings must be established to communicate with PSII if messages are sent to the ZebraNet Alert.

- In the *ZebraNet Alert* dialog, from menu bar, select **View>Filter Settings**.
- From the *View Filter - Devices* tab, choose your settings accordingly.



**Note** • If you select No device filtering, messages from every printer are caught; Device Address allows you to specify which IP address data will come from.

- The **View Filter - Events** tab allows you to select individual events you want the program to be aware of.



**Important** • Now PSII's SNMP Alert messages can be set up in WebView. From the printer's home page, activate the link to Alert Setup. You can add messages that are sent to the ZebraNet Alert for Windows by choosing SNMP as a destination.

## Sending Email to Your Zebra Printer

To easily transfer instructions and data to your printer from a remote location, PSII allows you to send email to the printer. This is set up under the link POP3 Email Printing. You need to provide the address of the network POP3 server, a user name, and a password.

With this option, you can create a text-based email containing ZPL II code and transfer it to the printer.



**Note** • Email attachments sent to the printer are not supported.

By using the proper ZPL II commands, files can be saved, loaded, printed, copied, and deleted, just as if the data were transferred from a serial or parallel port.

**To access POP3, complete these steps:**

1. From the Printer Home page, click [Print Server Settings](#).

The *PrintServer* page opens:

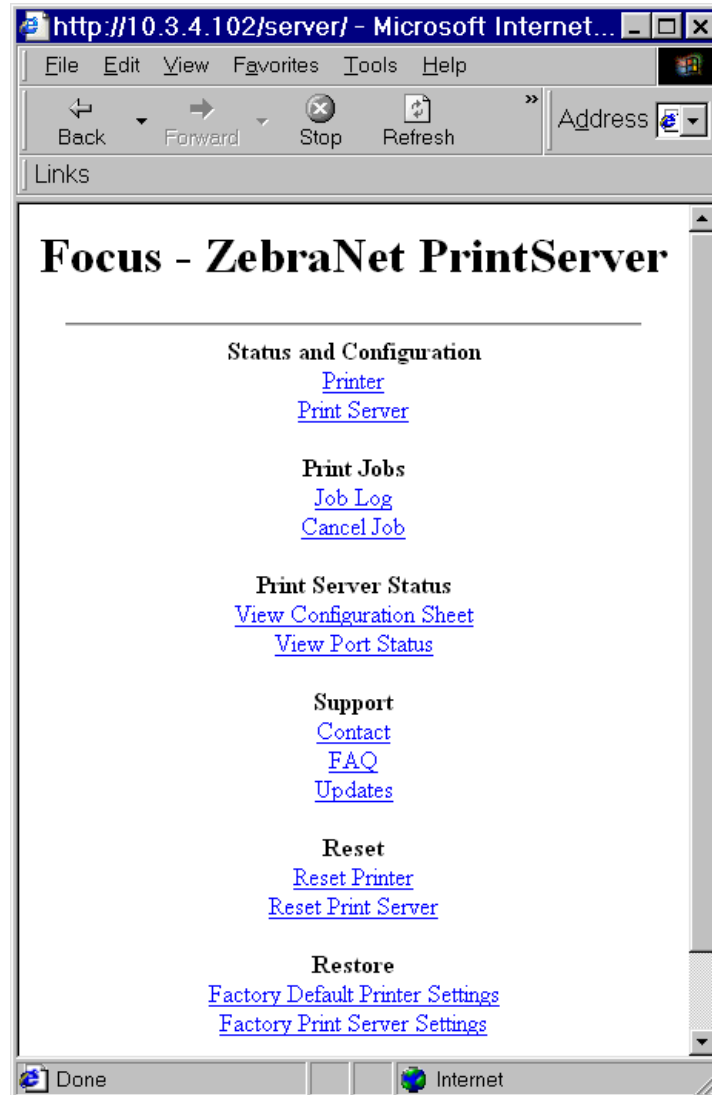



- From the *PrintServer* page, click [Print Server](#).

The *Print Server Configuration* page opens:

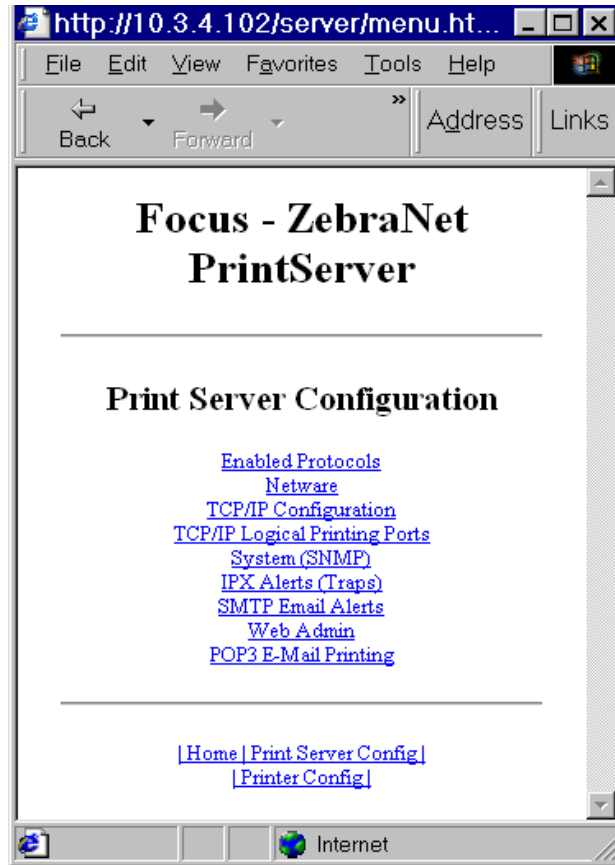

3. From the *Print Server Configuration* page, click [POP3 E-mail Printing](#).  
The *POP3 Printing Configuration* page opens:

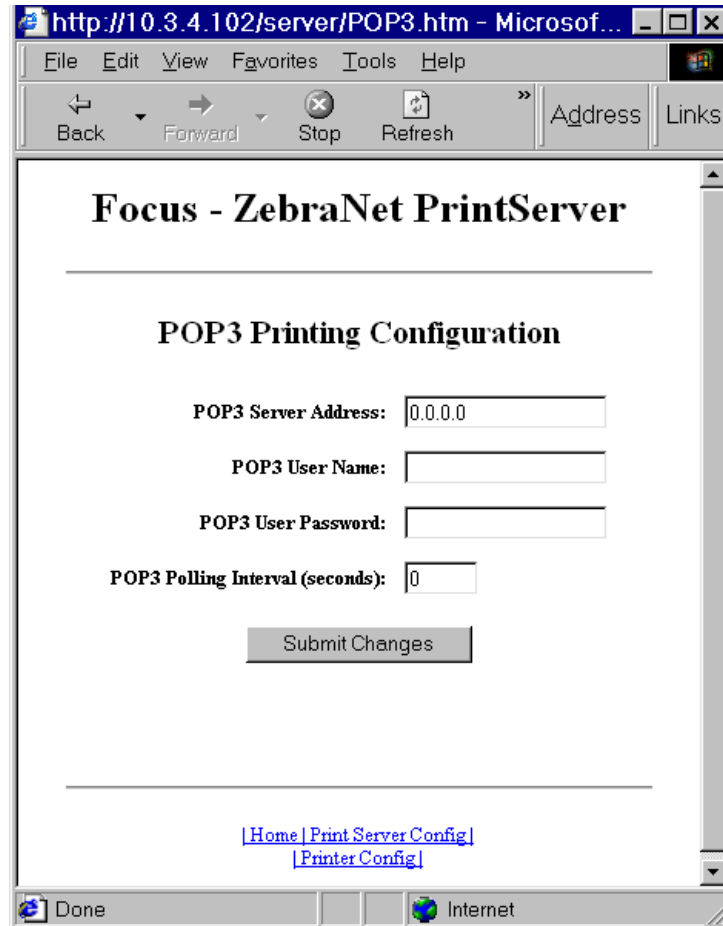

4. Make the necessary changes, and click **Submit Changes**.

ZebraNet Alert monitors status and activity of all Zebra printers on the network. It alerts the administrator when there is an error condition, which reduces printer downtime and increases application efficiency.

## Open Alert

To open ZebraNet Alert, complete these steps:

1. From the task bar, select Start>ZebraNet Utilities>ZebraNet Alert.
2. In the *ZebraNet Alert* dialog, from the menu bar select Report>. The report menu option has multiple report selections.
3. Select the type of report you want to generate.

This is an example of the *Event Summary* report. Notice it generates a .log file:

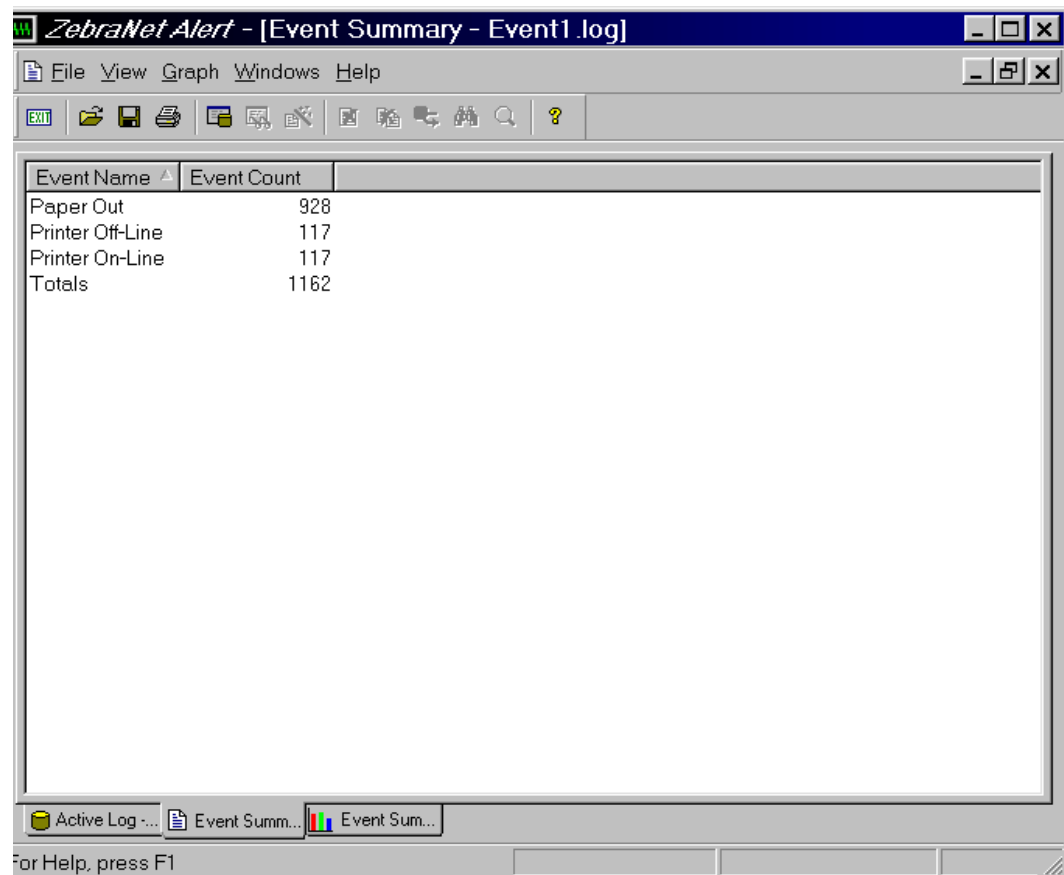

## ZebraNet Connect

For details, see *Setting Up a ZebraNet Connect IP* on page 63.

## ZebraNet View Java Applet

ZebraNet View Java Applet is a Java-based version of ZebraNet View. This can run on any enabled platform that can run a Java virtual machine, such as Windows, UNIX, Linux, and many others.



**Important** • To use this, you must have installed it with ZebraNet Utilities and then installed this application. For installation instructions for ZebraNet Utilities, see *ZebraNet View Java Applet on page 40*.

### To access ZebraNet View Java Applet, complete these steps:

1. From the task bar, select Start>Programs>ZebraNet Utilities>ZebraNet View Java Applet 1.0.

This view opens:

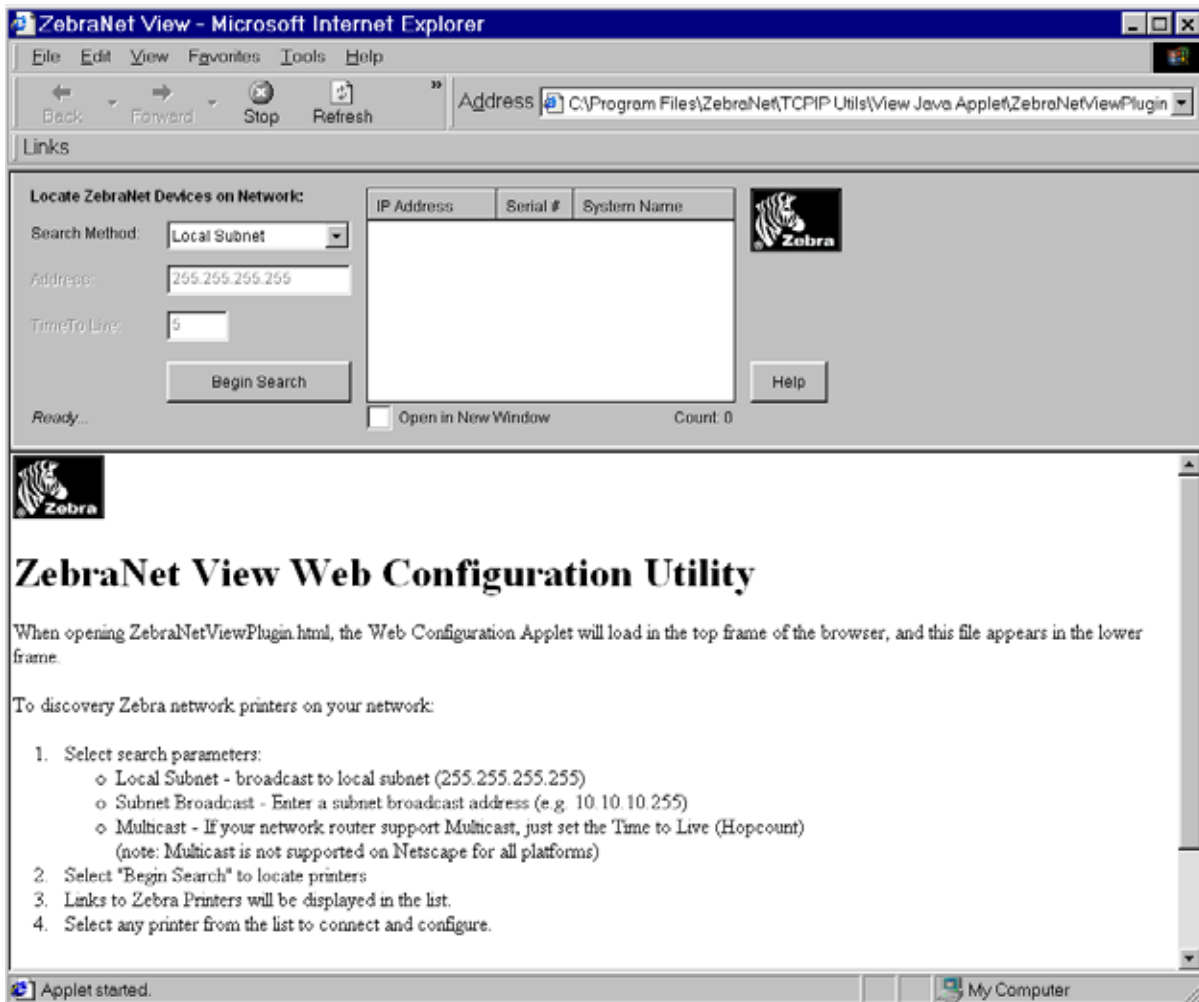

2. In the *Search Method* drop-down list box, select the search method you want.
3. Click **Begin Search**.  
It searches your network for all networked Zebra printers, discovers them, and lists them.
4. When you select a device from the list that is discovered, the selected device's *Home Page* displays in the lower portion of the view (it replaces the *ZebraNet View Web Configuration Utility* content).





---

# Hardware Troubleshooting

This provides you with solutions to known issues.

## Contents

Troubleshooting the PSII .....	130
Resetting to Factory Defaults .....	130
Status Indicator .....	130
ZebraNet View Utility Discovery or Configuration Problems .....	131
Unable to Print .....	131
Unable to Configure Device .....	131
HP JetAdmin or HP Web JetAdmin .....	131

## Troubleshooting the PSII

### Resetting to Factory Defaults

To reset the PSII configuration parameters to the factory defaults, press the Test button and hold it in while turning the printer power on. Keep the test button pressed until the Status Indicator light turns green, then release the test button. After approximately 20 seconds, a configuration label prints automatically.

### Status Indicator

A bi-color Status Indicator displays the operational status of the PSII. The following conditions might occur:

- During normal operation, the LED is solid green for more than 30 seconds. This indicates all the hardware is functioning properly and it has detected the presence of the network. It does not mean the PSII has an IP address or is attached to a printer queue.
- If the LED is rapidly flashing green (9 times/sec), the PSII has not detected the presence of a network cable. To solve the problem:
  - Turn the printer power off. Remove the network cable from the PSII. Plug the network cable back in until you hear a positive click. Check the other end of the cable in the same manner. Turn the printer power on. If the PSII still does not detect a cable, continue.



**Important** • Cables with a rating higher than CAT-5 have not been tested.

- Verify that the network cable is 10BASE-T and has an RJ-45 connector.
- Connect the PSII to a network drop that is a known good network connection. If the PSII is still unable to detect the network cable, contact Technical Support for assistance.
- If the LED is slowly flashing green (1 time/sec), the PSII is trying to print a job. If the job does not print, check the following:
  - Verify that the printer has media and ribbon (if in thermal transfer mode). If the printer is showing any errors, it is unlikely that the PSII can send data to the printer. The LED continues to blink until the printer malfunction is resolved or until the printer is turned off.
  - Flashing red indicates the Power On Self Test (POST) is in progress.
- If the LED is solid red for more than 30 seconds, the PSII has failed the POST. If the failure is not severe, the PSII attempts to print a configuration label on the printer. A failed POST can be caused by any of the following:
  - The printer attached to the PSII device is malfunctioning. Turn the printer power off, wait 10 seconds, then turn the printer back on.
  - If the PSII still fails the POST, continue below. The PSII has a hardware problem that can be fixed only by replacing or returning the unit. Contact Technical Support for repair or replacement information.



- If the LED is alternately flashing red and green for longer than 2 minutes, the PSII is in firmware-download mode. This means it is waiting for new firmware data to be sent before it continues normal functioning. Perform the following:
  - If the PSII was purposely put into firmware-download mode, finish the download with the proper update utility. Contact the Zebra Web site at <http://www.zebra.com> to download this utility.
  - Contact Technical Support for help recovering this unit.

## ZebraNet View Utility Discovery or Configuration Problems

If you are having problems using the ZebraNet View utility to discover or configure the unit, check the following:

- Verify there is not a router between the workstation running ZebraNet View and the PSII. Because the PSII does not have an IP address, TCP/IP communication cannot be started across a router. Run ZebraNet View on the same subnet as the PSII. This is not a limitation when using ZebraNet View for HP JetAdmin in IPX/SPX Discovery Mode.
- Verify the PSII has a solid green light. If the LED shows a rapidly flashing green light, check the network cable that is attached.

## Unable to Print

- If you are having problems printing, verify that there is communication between the PSII and the printer. Check the following:
  - Print a configuration label by pressing the test button on the PSII. If a configuration label does not print, verify the printer has media and ribbon (if used) and is not paused.
  - If problems persist, contact Technical Support.

## Unable to Configure Device

To assign an IP address to a ZebraNet PSII using ZebraNet View, you must be on the same subnet. If ZebraNet View has Multicast enabled, you might be able to view the ZebraNet PSII on another subnet, but you will not be able to configure the device.

## HP JetAdmin or HP Web JetAdmin

The ZebraNet PSII might be set up and managed using HP JetAdmin or HP Web JetAdmin products.



**Notes •** \_\_\_\_\_

\_\_\_\_\_

\_\_\_\_\_

\_\_\_\_\_

\_\_\_\_\_

\_\_\_\_\_

\_\_\_\_\_

\_\_\_\_\_

\_\_\_\_\_

\_\_\_\_\_

\_\_\_\_\_



---

## Frequently Asked Questions

This is a group of frequently asked questions (FAQs) about PSII.

### **Contents**

FAQs .....	134
------------	-----

## FAQs

This table provides frequently asked questions (FAQs) on PSII:

Question	Answer
<p><b>Are there any differences in functionality between a ZebraNet PSII with an EPL-based printer and with a ZebraLink-enabled ZPL printer?</b></p>	<p><b>Yes.</b></p> <ul style="list-style-type: none"> <li>• In a ZebraLink environment, with either a Web browser or with the ZebraNet View Utilities, there are a variety of Web pages that display a wealth of status information regarding both the ZebraLink printer and its ZebraNet PSII. However, when used with an EPL printer, such as the LP/TLP 2844, the Web pages for printer status are not available at this time, only the Web pages showing status of the PSII are displayed. The PSII can be easily configured. However, printer configuration information regarding the EPL printer is not available via the ZebraNet Utilities.</li> <li>• Error conditions: Using ZebraNet Alert, an EPL printer can be configured to use different IP addresses to report the following Alert status conditions: on-line, off-line, paper out.</li> <li>• For EPL: only two destinations can be configured to report error messages (online, offline, and paper out) using SMTP email alert – serial and parallel port destinations are not supported.</li> </ul>
<p><b>Can the internal ZebraNet PSII option work on a computer network that is running both TCP/IP and IPX protocols simultaneously?</b></p>	<p><b>Yes.</b></p> <p>The ZebraNet PSII runs all of its available protocols simultaneously. This means that the ZebraNet PSII can run on mixed networks such as a network using Microsoft, UNIX, and Novell NetWare operating systems.</p>
<p><b>Will the ZebraNet PSII allow connectivity to anything other than a PC network?</b></p>	<p><b>Yes.</b></p> <p>The ZebraNet PSII allows connectivity to systems such as IBM's AS400, provided that it is configured using TCP/IP. Other network protocols can be used with third-party adapters that are converted to 10BASE-T.</p>
<p><b>Will the ZebraNet PSII option work on a 100BASE-T per second network?</b></p>	<p><b>No.</b></p> <p>The ZebraNet PSII option is a 10BASE-T print server. This means that the data cannot travel any faster than 10 megabits per second. The ZebraNet PSII can be deployed on a network that is utilizing 10/100 hubs, but the ZebraNet PSII operates at only 10 megabits per second.</p>

Question	Answer
<p><b>What if a print job makes it to the queue, but never leaves the queue? The label does not print.</b></p>	<p>These are the things to check:</p> <ul style="list-style-type: none"> <li>• Confirm that the printer is turned on and receiving power.</li> <li>• Confirm that the network cable is plugged in and that you can ping the printer.</li> </ul> <p>If the above bullets do not change the outcome, it is likely that there was a misconfiguration while creating the queue. The queue must be recreated verifying the following:</p> <ul style="list-style-type: none"> <li>• Confirm that you use the print server's valid IP address.</li> <li>• If you are using a UNIX or AS/400 host, there is an option for the remote queue name. There is only one valid response to use: PORTLF1.</li> <li>• If Windows does not have LPR installed, the above required option should be left blank.</li> <li>• See the documentation for other operating system specific queue creation.</li> </ul>
<p><b>What are the minimum requirements to network a printer?</b></p>	<ul style="list-style-type: none"> <li>• Cat-5 network cable with 10BASE-T connectors</li> <li>• PSII</li> <li>• Hub or Switch</li> <li>• If a hub or switch is NOT used, you need a cross-over cable.</li> <li>• Workstation running a TCP stack with print services installed</li> </ul>
<p><b>What do the activity lights on the PSII mean?</b></p>	<ul style="list-style-type: none"> <li>• Fast blinking (9 times/second) — no link status</li> <li>• Slow blinking (1 time/second) — no IP address, or the unit is sending data to the parallel port</li> <li>• Blinking red — unit is still in POST</li> <li>• red-green-red-green — unit is in Netware firmware update mode</li> <li>• red-red-green-green — unit is in IP firmware update mode</li> <li>• Solid red — unit has failed POST. Remove network cable and restart printer</li> </ul>
<p><b>What is the default User ID and password for the print server?</b></p>	<ul style="list-style-type: none"> <li>• The User ID is admin and the password is 1234.</li> </ul>

Question	Answer
<p><b>What ports are open on PSII and related software?</b></p>	<p>TCP Ports:</p> <ul style="list-style-type: none"> <li>• 21 FTP</li> <li>• 23 Telnet</li> <li>• 80 HTTP Server</li> <li>• 515 Printer port</li> <li>• 631 IPP port</li> <li>• 9100 Raw socket connection</li> </ul> <p>UDP Ports:</p> <ul style="list-style-type: none"> <li>• 161 SNMP broadcast from PSII</li> <li>• 162 SNMP trap on ZebraNet Alert</li> <li>• 4201 discovery destination on PSII</li> <li>• (dynamic) SNMP get request from ZebraNet View</li> <li>• (dynamic) discovery broadcast from ZebraNet view</li> <li>• (dynamic) discovery broadcast from ZebraNet view Java</li> </ul>
<p><b>What are my network connectivity options based on when using a PSII?</b></p>	<p>It depends on your environment, but the print server accepts print jobs in any of the following ways:</p> <ul style="list-style-type: none"> <li>• FTP — ZPL/EPL files can be sent to the printer via a FTP client as standard ASCII files</li> <li>• HTTP — (ZebraLink-enabled printers only) Using the script option of the print server’s homepage, you can type ZPL into a specified location of the Web browser and send it to the printer</li> <li>• IPP — Using third-party IPP clients, print jobs can be sent via the internet</li> <li>• LPR/LPD — Sometimes referred to as queue based printing. LPR/LPD is the standard in network printing. Most TCP/IP operating systems are compatible with this option</li> <li>• Raw socket connection — You can connect to the printer directly via the network, bypassing everything in-between. This option is commonly used to integrate ZPL/EPL into existing programs, such as VB scripts</li> <li>• POP3 — With proper configuration, you can place ZPL/EPL files into the body of an email, and it will print. The print server periodically checks this email box at the specified intervals and prints the body of the message. IMPORTANT: attachments and subject line are not supported</li> </ul>

---

# Glossary



**10BASE-T** A type of Ethernet that uses unshielded twisted pair cable.

**arp** The standard TCP/IP method for determining the actual network address of a device based on its IP address.

**ASCII** A standard for the binary representation of characters.

**BOOTP** BOOTP (Bootstrap Protocol) is a protocol that lets a network client configure automatically. It can automatically configure any of the following information: IP address, gateway, subnet, system name, name server, and more. It automatically assigns the necessary settings from a pool of pre-determined addresses for a certain duration of time. BOOTP is the basis for a more advanced network manager protocol, the DHCP (Dynamic Host Configuration Protocol).

**broadcast** In a network, a situation when all destinations on the network receive a given packet.

**client** A workstation or PC in a client/server environment.

**community** For SNMP, a relationship between an agent and a set of SNMP managers that defines security characteristics. The community concept is a local one, defined at the agent. Each community is given a unique community name.

**DHCP (Dynamic Host Configuration Protocol)** DHCP is an alternative to another network IP management protocol, Bootstrap Protocol (BOOTP). Like BOOTP, DHCP can configure an IP address, gateway, subnet, system name, and name server. When speaking about the PSII, BOOTP, and DHCP configure the same options.

**delete bytes** This number is used to remove characters from the beginning of every job sent to the logical printer. The value for delete bytes can range from 0 to 255.

**dynamic** A dynamic configuration, as the name implies, means that it changes. BOOTP and DHCP offer time-based leases for the configurations they assign. Their changes depend on the time-based lease, and how often the printer itself is offline and online again. A dynamic configuration includes BOOTP or DHCP.

**EPL** Eltron Programming Language.

**Ethernet** A widely used local area network system based on the IEEE 802.3 standard.

**firmware** Software routines that are stored in ROM (Read Only Memory). This is typically part of a device, such as a printer or PSII.

**FTP** File Transfer Protocol, a TCP/IP-related protocol for transferring files between devices on a network.

**Flash memory** A type of memory that allows read-and-write operations, but permanently stores data when the power is turned off. Useful for storing firmware because it can be easily updated by downloading new code.

**gateway** A device that converts one higher-level network protocol to a different higher level protocol.

**gleaning** A temporary, local configuration option. Gleaning lets you add the address of the device you want to configure to your local workstation's arp table. This configuration is not permanent and is valid only from the workstation from which you entered the arp information. After the information is entered into the workstation's arp table, the user follows up with a Telnet session to enter the information permanently. This configuration option is used mostly by non-Windows workstations that cannot run the ZebraNet View configuration utility.

**IP** Internet Protocol, one of the main protocols of the TCP/IP protocol suite.

**IP address** A network address used by the TCP/IP protocol.

**IPP** Internet Printing Protocol. Allows you to associate a printer with a URL address that is used for printing over the Internet.

**IPX** Internetwork Packet Exchange, one of the NetWare protocols.

**JetAdmin** A Hewlett-Packard printer management program available for NetWare and TCP/IP.

**logical** Refers to conceptual rather than physical. For example, a computer might have a single physical connection to the network (an Ethernet adapter card), but could have logical connections to several other devices on the network.

**MAC Address** Media Access Control. Ethernet address that corresponds to the assigned IP address.

**name server** A workstation on a TCP/IP network that provides a list of all workstations on the network.

**NetWare** A network operating system developed by Novell.



**node** A device connected to a network, such as a computer or print server.

**parallel port** A port on a device that sends information in groups of bits over multiple wires, one wire for each bit in a group.

**ping** A TCP/IP command that determines whether a device is accessible on the network.

**POP3** Post Office Protocol, the protocol used to retrieve email from the server.

**port** A physical connector, such as the parallel port, or a logical connection to a device.

**post string** A string that is sent at the end of every job going to the logical printer. Maximum 64 characters long.

**pre string** A string that is sent at the beginning of each job that goes to the logical printer. Max 64 characters long.

**print server** A device in a network that changes a network protocol into a printer protocol.

**protocol** A method of sending and receiving data between two or more workstations on a network, and insuring that the data is received without errors.

**rarp** Reverse Arp, a standard TCP/IP method of determining a device's IP address based on its Ethernet address.

**raw TCP port** A type of TCP port in which data is passed unmodified to the receiving node.

**RJ45** A type of modular jack connector similar to a telephone connector with up to eight wires. Used for 10BASE-T Ethernet connections and for serial port connections.

**serial port** On a printer or print server, a port that transfers data one bit at a time. Serial ports usually have either a 25-pin, 9-pin "D", or RJ45 connector.

**server** A device on a local area network that provides services to client computers on the network.

**SMTP** Simple Mail Transfer Protocol, a protocol used to send email messages over the Internet.

**SNMP** Simple Network Management Protocol, a protocol for monitoring and controlling devices on a network.

**spooling** In printing applications, spooling is the transfer of data to a temporary storage area on disk (the print queue) prior to printing. Spooling allows many jobs to be queued to a single printer.

**static** Refers to a static IP address. All information is provided by the network administrator.

**subnet mask** A TCP/IP method of dividing a network into several smaller subnetworks.

**TCP/IP** Transmission Control Protocol/Internet Protocol, the de facto standard for Internet communications that is widely used on local area networks.

**TCP Port** A method of accessing a TCP/IP service, where a device with a single IP address can have multiple TCP ports.

**Telnet** A TCP/IP protocol that allows two devices to communicate over a LAN.

**trap** An unsolicited message sent by an SNMP agent to an SNMP management station. It notifies the management station of some unusual event.

**UNIX** A general-purpose computer operating system used on many different kinds of computers.

**WCSO** Wireless Card Socket Option. Zebra's wireless Ethernet option.

**Windows 95 and Windows 98** Microsoft's PC operating systems that feature built-in peer-to-peer networking.

**Windows NT** Microsoft's multitasking operating system that can be used either as a client or as a server.

**Windows 2000** Microsoft's multitasking operating system that replaces Windows NT; can be used as either as a client or as a server.

**ZebraNet PrintServer II** An Ethernet connectivity solution.

**ZebraLink** Allows you to connect and control your bar code printers anywhere and anytime.

**ZPL II** Zebra Programming Language II is a powerful label-definition and printer-control language.

---

# Index



## A

- about this document 10
- address
  - configuration label 45
- alerts
  - establishing email messaging 55
  - monitoring with ZebraNet Alert 57
  - setting 52
  - setting in ZebraLink 54
  - setting in ZebraNet View 52
- assigning an IP address 46
  - using gleaning
    - how to 50
  - using static route
    - how to 50
  - with DHCP 46
  - without DHCP 46
  - ZebraNet View 46

## B

- before you begin
  - getting started 44
- browser support
  - requirements 18
- BSD-Style
  - print configuration 74

## C

- configuration label 26
  - address 45
  - default gateway 45
  - fields to know 45
  - hardware address 45
  - how to print 44
  - MAC address 45
  - serial number 45
  - subnet mask 45
  - with numbers 26
- configuration setting
  - browser 60
  - with a browser 60
- configuration settings
  - ZebraNet View 58
- contacts 11
- Contents 5
- customer service 11

## D

- default
  - password 86
  - user ID 86
- default factory settings
  - PSII ZebraNet View 71
- default gateway
  - configuration label 45
  - how to set 48
- default PSII factory settings
  - test button 72
  - with WebView 70
- Document Conventions 12

- document conventions 12
  - caution 12
  - command line 12
  - hot links 12
  - important 12
  - note 12

**E**

- email messaging
  - alerts 55
- external PSII
  - how to install 24
  - illustration 24
  - installation 24

**F**

- factory installation 21
- field installation 21
- File Transfer Protocol 83
- FTP 83

**G**

- gleaning 50

**H**

- hardware
  - requirements 19
- how to install
  - external PSII 24
  - internal PSII 32
- HP JetAdmin
  - troubleshooting 131
- HP Web JetAdmin
  - troubleshooting 131

**I**

- illustration
  - external PSII 24
- installation
  - external PSII 24
  - internal PSII 27
  - ZebraNet Utilities 37
  - ZebraNet View Java Applet 40
- installation types 21
  - factory 21
  - field 21

- internal PSII
  - how to install 28, 32
  - installation 27
  - tools to install 31
- IP address
  - assigning in telnet session 49
  - how to assign 47
- IP address assigning
  - in a non-Windows environment 49
- IPP
  - support 82
- IPX 65

**L**

- liability 3

**M**

- MAC address
  - configuration label 45
- media
  - ordering 11

**N**

- NetWare
  - attach generic text driver 79
- NetWare print configuration 77

**O**

- ordering ribbon and media 11
- overview 16
  - illustration 16
- overview illustration
  - explanation 16

**P**

- parallel port locations
  - illustration 25
- password
  - default 86
- prerequisites
  - System V 75
- print configuration
  - BSD-Style 74
  - System V 75
- print problems
  - troubleshooting 131
- print protocol
  - Internet printing protocol 82
  - IPP 82

- printing
  - configuration label 44
  - PServer mode 78
- protocols
  - how to enable with WebView 66
  - how to enable with ZebraNet View 69
- PServer mode
  - printing 78
- PSII
  - settings 62
  - specifications 22
- PSII settings
  - how to access 86

## R

- related documents 14
- requirements
  - browser support 18
  - hardware 19
- resetting to factory defaults
  - troubleshooting 130
- ribbon
  - ordering 11

## S

- sales 11
- serial number
  - configuration label 45
- setup PSII port
  - Windows 95/98 64
- specifications 22
- static route 50
- status indicator
  - troubleshooting 130
- subnet mask
  - configuration label 45
  - how to set 48
- System V
  - prerequisites 75
  - print configuration 75
  - UNIX configuration 75

## T

- technical support 11

- test button
  - default PSII factory settings 72
- troubleshooting
  - HP JetAdmin 131
  - HP Web JetAdmin 131
  - resetting to factory defaults 130
  - status indicator 130
  - unable to configure device 131
  - unable to print 131
  - ZebraNet View Utility 131

## U

- unable to configure device
  - troubleshooting 131
- user ID
  - default 86

## W

- WebView
  - default PSII factory settings 70
  - directory listing 108
  - how to enable protocols 66
  - printer configuration 102
  - view and modify printer settings 103
- Windows 95/98
  - setup PSII port 64

## Z

- ZebraLink
  - setting alerts 54
- ZebraNet Alerts
  - monitoring alerts 57
- ZebraNet Connect IP 63
  - Windows NT 4.0 / Windows 2000 63
- ZebraNet Utilities
  - how to install 37
  - installation 37
- ZebraNet View
  - configuration settings 58
  - how to enable protocols 69
  - PSII default factory settings 71
  - setting alerts 52
- ZebraNet View Java Applet
  - how to install 40
  - installation 40







**Zebra Technologies International, LLC**

333 Corporate Woods Parkway  
Vernon Hills, Illinois 60061.3109 U.S.A  
T: +1 847 793 2600  
Toll-free +1 800 423 0422  
F: +1 847 913 8766

**Zebra Technologies Europe Limited**

Dukes Meadow  
Millboard Road  
Bourne End  
Buckinghamshire, SL8 5XF, UK  
T: +44 (0)1628 556000  
F: +44 (0)1628 556001

**Zebra Technologies Asia Pacific, LLC**

120 Robinson Road  
#06-01 Parakou Building  
Singapore 068913  
T: +65 6858 0722  
F: +65 6885 0838

<http://www.zebra.com>